

Tomorrow's Technology Today

TECHNICIAN'S CHOICE®

PROFESSIONAL SERIES

**APPEARANCE AND RECONDITIONING
PREP AND SERVICE CHEMICALS**

**Automotive • Fleet • Truck & Transportation
Janitorial • Automatic Car Wash**

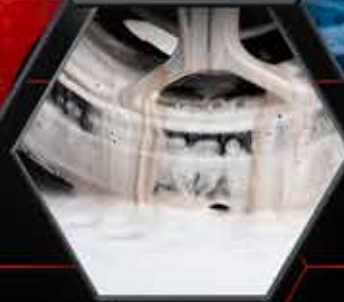

PLATINUM
PROFESSIONAL CAR WASH SYSTEMS®

ABOUT ECP

ECP Incorporated, one of the oldest and most trusted names in the Automotive Industry, features its Technician's Choice® and Platinum Professional Car Wash Systems® programs. Since 1969, ECP has delivered proven chemistry, product innovation and merchandising targeted to increase revenue traffic. Technician's Choice® is a major market segment of ECP's line of professional products - Auto Armor®, The Protector®, Platinum Protection Systems®, Tornador®, Fragrances Unlimited®, Detail Xpress™ and Platinum Professional Car Wash Systems®.

Tomorrow's Technology Today

TECHNICIAN'S CHOICE®

PROFESSIONAL SERIES



A Family of Brands

Professional Detailing, Prep, Reconditioning & Service Chemicals

Quality products for Prep, Detailing, Reconditioning, Service & Body Shop Departments plus specialty products, aerosols, facility maintenance, bench chemicals, shop supplies and equipment.

www.technicianschoice.net

Tornador Professional Cleaning Tools

TORNADOR® Car Cleaning Tools are the fastest and easiest way to clean all automotive surfaces. The TORNADOR® works with your air compressor to blast cleaning solution into crevices you can't reach by hand. Clean carpet, plastics, and upholstery inside the car. Clean wheels, convertible tops, and body seams on the exterior. The TORNADOR® Car Cleaning Tool cleans where other tools can't!

www.tornador.us

Professional Car Wash Chemicals

A complete line of professional series products created and formulated exclusively for tunnel, automated or handwash operations; complemented by a full merchandising and signage program.

www.platinumcw.net

Appearance & Protection Systems

(Sold Exclusively Through New Car Dealers)

A diversified line of products and programs for new car dealers which include: Protective Coatings for new, used, and leased vehicles, Optional Protection Products and Customer Appreciation Programs.

www.ecpinc.net

ECP's National Training Center

ECP provides a variety of comprehensive training courses that put you to the test while hands-on courses teach the methods that are proven.



*Serving the Automotive Industry since 1969
Innovations in Chemistry since 1935*

ECP'S COMMITMENT TO GREEN

Get it clean, and keep it green!

When the symbols shown here appear by products listed in this catalog, it is your assurance that those products will leave a smaller environmental footprint and deliver a competitive edge for your business.



Green Product

Our super concentrated products that are manufactured in our own energy efficient facility have less water, which in turn consumes less energy in shipping. More concentrate gives you more product by volume, thus less packaging, less waste and lower shipping costs overall.

When you see the "Green" symbol know that you are getting the highest quality product with the lowest environmental impact.



VOC/OTC Compliant

When you see this symbol with a Technician's Choice product you can be assured you will be getting a product that is VOC/OTC Compliant. "VOC/OTC Compliant" means that the products meet the local, state or federal regulations for the product category. In short, VOC/OTC compliant products are better for the environment because they emit less ozone depleting organic compounds into the atmosphere. It is considered environmentally responsible to do so. For more information on VOC/OTC products for your state visit: www.envcap.org/statetools/srt/srt.html.

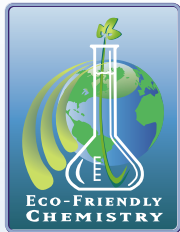

Environmentally Friendly

Products that carry this hallmark have chemistry that is environmentally friendly and are the ideal alternative to the hazardous, toxic chemicals often used in demanding commercial and industrial applications. Products made from renewable resources that are biodegradable, chlorine free and phosphate free yet retain all of the power of their chemical counterparts. Custom formulas improve worker safety and have a less harmful effect on the environment.



Body Shop Safe

Products that feature this symbol are those that contain no silicone and therefore are safe to use within the body shop area.

TABLE OF CONTENTS

Aerosols	6-15
Brake & Parts Cleaners	6
Underhood	7
Detailing	8-9
Fragrance Bombs	10
Lubricants & Protectants	11
Spray Paints & Dyes	12-13
Specialty Products	14
Detail Xpress™	15
Cleaning Products	16-43
Air Fresheners & Fragrances	16-17
All-Purpose/Multi-Purpose Cleaners	18-22
Car Wash	24-27
Floor Cleaners	28-29
Glass Cleaners	30-31
Hand Cleaners	32-33
Interior Cleaners	34-35
Janitorial & Disinfecting	36-37
Odor Eliminators	38-39
Specialty Cleaners	40-41
Tire/Wheel Cleaners	42-43
Degreasers	44-45
Solvent-Based	44
Water-Based	45
Dressings	46-51
Solvent-Based Non-Silicone	46
Solvent-Based Silicone	46-48
Water-Based Non-Silicone	49
Water-Based Silicone	49-51
Equipment	52-62
Buffers/Polishers	52-53
Extractors	54-55
Miscellaneous	56-57
Tornador®/Foam-A-Nator	58-62
Merchandise	64
Signage - Windmaster Inserts & Banners	64
Paint Correction	66-79
Correct-It Clay System, Clay Bars, Clay Mitts, Clay Towels & Lubricants	66-67
Paint Correction Chart	68-69
Product Line Card	70-71
XPC3® Xtreme Paint Correction System	72-73
Compounds, Polishes & Glazes	74
XPC3® Ceramic Protection Products	75
G-MAX® Graphene Products	76
Waxes & Sealants	78-79
Specialty Products	80-83
Service Lane Products	80
Miscellaneous - Cleaners, Polishes, Removers and more	81-83
Supplies	84-107
Applicators & Cloths	84
Brushes	86-87
Dispensers & Proportioners	88-89
Miscellaneous	90-91
Pads & Buffing Supplies	92-95
Paper Towels & Toilet Paper	96-97
Plastic & Paper	98-99
Safety Supplies	100-101
Squeegee, Mops & Brushes	102
Towels & Polishing	103
Transfer Containers, Sprayers & Racks	104-105
Wash & Dry	106-107
National Training Center	108-109
TEC INDEX	134-135



When you see this symbol associated with our products, please note that this is a special order item and that it may require additional time for production and/or shipping.



Table of Contents

Products (by category)	PAGE(S)
Pre-Soaks	112-113
Alkaline (High pH)	112
Neutral pH • Acidic (Low pH)	113
Brake, Wheel & Whitewall Cleaners	114
Soaps & Detergents	115
Tri-Foam Polishes & Conditioners	116-117
Polishes / Conditioners • Foamy Lubes	116
FASTBREAK (High pH) • FASTBREAK (Low pH)	117
Rinse Agents & Protectants	118-120
Drying Agents • TVP • Protectants	118
Lava Waxes	119
Platinum Ceramic Shield®	120
Tire Dressings - Water Based • On-Line	121
Specialty Products	122-123
Bug Removers • Tunnel & Equipment Cleaner • Laundry Detergent & more	122
Fragrance Boosters	123
Equipment	124-125
Dosatrons • Regulator • Proportioners	124
Titration Kit • Graduated Cylinders	125
Signage	126-129
Banners	126
Windmasters & Frames	127-128
Cones & Drum Covers	129
Tables & Charts	130-131
PCW INDEX	136-137
Product Use Guide	138-139

Usage Symbols (PCW)

Our products are formulated for use in various types of wash applications. Use the legend below to help reference the symbol associated with each product. These symbols identify which specific wash application(s) are best suited for the respective products.

T Tunnel Wash
Products that feature this symbol are formulated for use in tunnel wash applications.

A In-Bay Automatic, Rollover, Touchless & Friction Wash
Products that feature this symbol are formulated for use with in-bay automatic, rollover, touchless and friction wash applications.

S Self-Service Car Wash
Products that feature this symbol are formulated for use in self-service wash applications.

If you can't find what you're looking for or don't see what you want, please call our Customer Service.

Call: 1.800.323.3521



BRAKE & PARTS CLEANER

AEROSOLS

CHLORINATED



TEC99202

Chlorinated Brake & Parts Cleaner

Dissolves & removes brake fluid, oil & grease from brake, clutch & electrical assemblies. Fast cleaning, fast evaporation.

Item	Available Size(s)	Pallet Count
TEC99202	12 - 18 oz. cans/case	(105 cases/pallet)

NON-CHLORINATED



TEC99312

Brake & Parts Cleaner

Blasts away grease & grime, helps remove brake fluid, grease, oily dirt & contaminants from linings, pads, drums, cylinders & springs. Evaporates quickly. Non-chlorinated.

Item	Available Size(s)	Pallet Count
TEC99312	12 - 13.5 oz. cans/case	(147 cases/pallet)



TEC99315

VOC/OTC Compliant Brake & Parts Cleaner

A non-chlorinated brake cleaner that contains no CFC's, is VOC Compliant and ozone friendly. This concentrated solvent blend provides maximum performance without the use of ozone depleting chlorinated solvents.

Item	Available Size(s)	Pallet Count
TEC99315	12 - 13 oz. cans/case	(147 cases/pallet)

BULK Brake, Tool & Parts Cleaners



See pages 81-83

Refer to SDS before use



AEROSOLS



TEC99201

Carb & Choke Cleaner

Unique impingement & flushing action provides fast cleaning. Dissolves gum & varnish. Oxygen sensor safe.

Item	Available Size(s)	Pallet Count
TEC99201	12 - 11 oz. cans/case	(147 cases/pallet)



TEC99206

Premium Carb & Choke Cleaner

Quickly and effectively cleans carburetors & linkages without disassembling or brushing. Oxygen sensor safe.

Item	Available Size(s)	Pallet Count
TEC99206	12 - 14 oz cans/case	(147 cases/pallet)



TEC99208

Throttle Body & Air Intake Cleaner

Throttle body & air intake cleaner cleans gum and varnish from the throttle valves and throttle body. For use in fuel injected gasoline engines (both throttle body & multi-port). Use for easier starting and smoother engine performance.

Item	Available Size(s)	Pallet Count
TEC99208	12 - 4.5 oz. cans/case	(147 cases/pallet)



TEC99407

Foaming Engine Degreaser

Effective in removing dirt, soil and grease. Fast acting; rinses easily. Concentrated foaming action.

Item	Available Size(s)	Pallet Count
TEC99407	12 - 16 oz. cans/case	(100 cases/pallet)



TEC99601

Battery Cleaner

Removes dirt, grease & corrosive deposits that can accumulate on battery surface.

Item	Available Size(s)	Pallet Count
TEC99601	12 - 11 oz. cans/case	(100 cases/pallet)



TEC99602

Battery Corrosion Preventative

Prevents build up of deposits on terminals that could cause poor contact & reduce current flow.

Item	Available Size(s)	Pallet Count
TEC99602	12 - 7.5 oz. cans/case	(100 cases/pallet)



TEC99603

Mass Air Flow Sensor Cleaner

Helps restore fuel economy. It safely cleans mass air flow sensors without harming delicate equipment.

Item	Available Size(s)	Pallet Count
TEC99603	12 - 13.5 oz. cans/case	(147 cases/pallet)

TEC99208 is used as Step 2 in our

TEC318



See pages 80 for details!

Always wear recommended safety equipment



DETAILING



AEROSOLS



TEC99090



Remove-All Adhesive Remover

Solvent-based. Removes adhesives, grease & tar. Removes undercoating overspray. Use on vinyl, upholstery & all hard surfaces.

Item	Available Size(s)	Pallet Count
TEC99090	12 - 14.5 oz cans/case	(100 cases/pallet)



TEC99307



Premium Glass Cleaner

For glass surfaces. Ideal for plastics, counter tops & porcelain coated appliances. Ammonia free. Features a "Finger Pad" Actuator.

Item	Available Size(s)	Pallet Count
TEC99307	12 - 20 oz. cans/case	(100 cases/pallet)



TEC99217



Instant Shine 50 State Compliant

Fifty state compliant formula. Fast drying release agent & conditioning spray for vinyl, rubber, plastic, painted interior & exterior surfaces. High gloss protectant penetrates deep into surfaces. Fortified with silicone, just spray & walk away. Leaves a long lasting, waterproof shine.

Item	Available Size(s)	Pallet Count
TEC99217	12 - 12 oz. cans/case	(100 cases/pallet)



TEC99308



Non-Ammoniated Glass Cleaner

Cleans & polishes. No streaking, free from ammonia & silicones. Cleans windshields, mirrors & more.

Item	Available Size(s)	Pallet Count
TEC99308	12 - 19 oz. cans/case	(100 cases/pallet)



TEC99217

Instant Shine Classic

Fast drying release agent & conditioning spray for vinyl, rubber, plastic, painted interior & exterior surfaces. High gloss protectant penetrates deep into surfaces. Fortified with silicone, just spray & walk away. Leaves a long lasting, waterproof shine.

Item	Available Size(s)	Pallet Count
TEC99217	12 - 12 oz. cans/case	(147 cases/pallet)



TEC99402



Upholstery Foam

Fast acting foam lifts dirt & stains from velour & cloth upholstery without scrubbing. Inverted Fan Tip.

Item	Available Size(s)	Pallet Count
TEC99402	12 - 12 oz. cans/case	(100 cases/pallet)



TEC99228



Spray Wax

A quick method for adding a 'Showroom Shine' with very little effort. Wax your entire vehicle in minutes. Protection, water beading & shine that lasts for weeks. No buffing needed. Will not leave a powder or dust residue on your finish. Fruity fragrance.

Item	Available Size(s)	Pallet Count
TEC99228	12 - 16 oz. cans/case	(100 cases/pallet)



TEC99408



Heavy Duty Stain Remover

Easily eliminates stains due to oil, tar, grease, mud, ink, coffee, urine, vomit, blood & more. Inverted Fan Tip.

Item	Available Size(s)	Pallet Count
TEC99408	12 - 18 oz. cans/case	(100 cases/pallet)

Refer to SDS before use



At our **NATIONAL TRAINING CENTER**, *hands-on* training gives you the techniques for the newest products we have developed for detailing applications.

For course information and class schedule:

Phone: **1-800-323-3521**

On-line: **www.technicianschoice.net**

See pages 108 - 109.

AEROSOLS



TEC99409



Foaming Carpet & Upholstery Cleaner

Foaming action for deep cleansing, releases ground in dirt. Perfect for spot cleaning spills & spot pick up. Dries to a powder. Inverted Fan Tip.

Item	Available Size(s)	Pallet Count
TEC99409	12 - 18 oz. cans/case	(100 cases/pallet)



TEC99410



Work Horse

All purpose cleaner formulated to clean any washable surface fast!

Item	Available Size(s)	Pallet Count
TEC99410	12 - 19 oz. cans/case	(100 cases/pallet)



TEC99411



Vinyl & Leather Cleaner & Conditioner

Conditions to protect & restore vinyl & leather. Removes stains, smudges & fingerprints. Restores gloss & maintains softness. Contains mink oil.

Item	Available Size(s)	Pallet Count
TEC99411	12 - 15 oz. cans/case	(100 cases/pallet)



TEC99413



Citrus Foam & Spotter

Fast & easy way to clean carpets & upholstery. Spray on & wipe off. Perfect for spot cleaning.

Item	Available Size(s)	Pallet Count
TEC99413	12 - 19 oz. cans/case	(100 cases/pallet)



Always wear recommended safety equipment

FRAGRANCE BOMBS

AEROSOLS



TEC99575



New Car Aerosol Bomb

A unique product that neutralizes all types of malodors. Effectively eliminates odors caused by urine, feces, decay, rancidity, smoke, fire, tobacco, cooking odors & mildew. New Car scent. Fan Tip.

Item	Available Size(s)	Pallet Count
TEC99575	12 - 5 oz. cans/case	(120 cases/pallet)



TEC99579



Neutral Aerosol Bomb

A unique product that neutralizes all types of malodors. Effectively eliminates odors caused by urine, feces, decay, rancidity, smoke, fire, tobacco, cooking odors & mildew. Neutral scent. Fan Tip.

Item	Available Size(s)	Pallet Count
TEC99579	12 - 5 oz. cans/case	(120 cases/pallet)



TEC99576



Red Hot Aerosol Bomb

A unique product that neutralizes all types of malodors. Effectively eliminates odors caused by urine, feces, decay, rancidity, smoke, fire, tobacco, cooking odors & mildew. Red Hot scent. Fan Tip.

Item	Available Size(s)	Pallet Count
TEC99576	12 - 5 oz. cans/case	(120 cases/pallet)



TEC99577



Berry Aerosol Bomb

A unique product that neutralizes all types of malodors. Effectively eliminates odors caused by urine, feces, decay, rancidity, smoke, fire, tobacco, cooking odors & mildew. Berry scent. Fan Tip.

Item	Available Size(s)	Pallet Count
TEC99577	12 - 5 oz. cans/case	(120 cases/pallet)



TEC99578



Lemon Lime Aerosol Bomb

A unique product that neutralizes all types of malodors. Effectively eliminates odors caused by urine, feces, decay, rancidity, smoke, fire, tobacco, cooking odors & mildew. Lemon Lime scent. Fan Tip.

Item	Available Size(s)	Pallet Count
TEC99578	12 - 5 oz. cans/case	(120 cases/pallet)

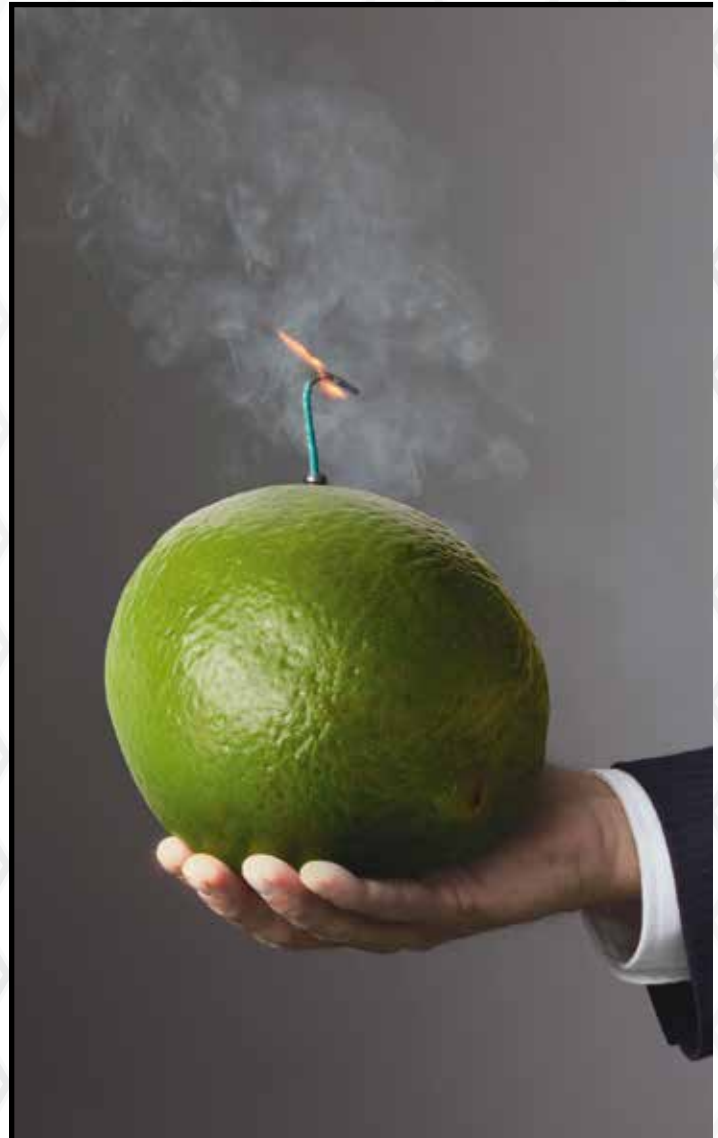

Refer to SDS before use

LUBRICANTS & PROTECTANTS

AEROSOLS



TEC99200
Silicone Lube



Waterproof lubricant that eliminates squeaks, insulates, prevents freezing & prolongs battery life.

Item	Available Size(s)	Pallet Count
TEC99200	12 - 10 oz. cans/case	(147 cases/pallet)



TEC99305
Invisalube



Premium, clear grease fortified with PTFE to resist water, heat & corrosion.

Item	Available Size(s)	Pallet Count
TEC99305	12 - 11 oz. cans/case	(95 cases/pallet)



TEC99203
Penetrant Lubricant



Penetrates & lubricates, stops rust, corrosion & squeaks. Will not harm rubber, plastics or paints.

Item	Available Size(s)	Pallet Count
TEC99203	12 - 11 oz. cans/case	(147 cases/pallet)



TEC99412
Premium White Lithium Grease



All weather, all purpose. Protects against corrosion & friction. Automotive, marine, home & farm use. Works well in high & low temperatures.

Item	Available Size(s)	Pallet Count
TEC99412	12 - 12 oz. cans/case	(140 cases/pallet)



TEC99204
White Lithium Grease



Features high levels of lubricity, corrosion protection, water, heat & cold resistance.

Item	Available Size(s)	Pallet Count
TEC99204 1	2 - 14 oz. cans/case	(147 cases/pallet)



TEC99416
Dry Lube



This lubricant is designed to stop squeaks, sticking & binding. Does not freeze. Made with a blend of silicones & has fast evaporating, non-chlorinated solvents.

Item	Available Size(s)	Pallet Count
TEC99416	12 - 13 oz. cans/case	(100 cases/pallet)



TEC99225
Blasting Penetrant



This aerosol is an easy, quick solution to loosening & removing rusted bolts, nuts & screws as well as aiding in the prevention of future corrosion. Can also be used as a lubricant in locks, hinges & various other moving parts. This product will not evaporate & works even if parts are wet as it will displace any moisture.

Item	Available Size(s)	Pallet Count
TEC99225	12 - 14 oz. cans/case	(100 cases/pallet)



Always wear recommended safety equipment

SPRAY PAINTS & DYES

AEROSOLS

AEROSOL Spray Paint - All Colors (below)

Available Size(s):

12 - 12 oz. cans/case

Pallet Count

(100 cases/pallet)



Spray paint formulated to meet the rigorous demands of most automotive & maintenance needs. These aerosol paints provide quick drying time; excellent coverage; high impact, slip and UV fade resistance.



TEC99100

TEC99101

TEC99103

TEC99104

TEC99105

TEC99106

TEC99107

TEC99108

TEC99150



TEC99100

Spray Paint - Dull Aluminum
Acrylic Lacquer paint.

TEC99100 12 - 12 oz. cans/case



TEC99101

Spray Paint - Flat Black
Enamel paint.

TEC99101 12 - 12 oz. cans/case



TEC99103

Spray Paint - Gloss Black
Enamel paint.

TEC99103 12 - 12 oz. cans/case



TEC99104

Spray Paint - Gloss White
Enamel paint.

TEC99104 12 - 12 oz. cans/case



TEC99105

Spray Paint - Gray Primer
Acrylic enamel paint.

TEC99105 12 - 12 oz. cans/case



TEC99106

Spray Paint - Clear Acrylic
Acrylic lacquer paint.

TEC99106 12 - 12 oz. cans/case



TEC99107

Spray Paint - Bright Aluminum
Lacquer paint.

TEC99107 12 - 12 oz. cans/case



TEC99108

Spray Paint - Satin Black
Enamel paint.

TEC99108 12 - 12 oz. cans/case



TEC99150

Spray Paint - Universal Black Engine Paint
Enamel paint.

TEC99150 12 - 12 oz. cans/case

Refer to SDS before use

AEROSOL Vinyl, Plastic & Carpet Dyes - All Colors (below)

Available Size(s)

Pallet Count

Provides a flexible, solid coating for interior & exterior applications. Clog resistant tip produces a wide fan spray pattern. When applied, these dyes dry quickly & evenly, creating a bond to resist cracking, peeling, splitting or rub offs.

12 - 11.25 oz. cans/case

(100 cases/pallet)



TEC99507
Carbon Gray



TEC99508
Light Gray



TEC99509
Silver Metallic



TEC99510
Smoke



TEC99511
Warm Gray



TEC99513
Graphite



TEC99514
Black



TEC99530
Sand



TEC99532
Beige



TEC99534
Desert Tan



TEC99535
Khaki



TEC99537
Dove Gray



TEC99538
Dark Gray Metallic



TEC99539
Flagstone



TEC99545
Tawny Gray

Always wear recommended safety equipment



SPECIALTY PRODUCTS

AEROSOLS



TEC99175

Headlight Coating

A clear, non-UV cured aerosol coating designed to protect the headlight after the appearance has been improved. Exhibits excellent adhesion, durability and UV resistance while helping to improve the functionality of the restored headlight. Easy to use; two-three coats recommended. One can treats up to 12 vehicles.

Item	Available Size(s)	Pallet Count
TEC99175	12 - 10 oz. cans/case	(100 cases/pallet)



TEC99211

Premium Rubberized Undercoating

Protects against corrosion, deadens sound. Improves flexibility for extreme heat & cold. Dries quickly. Paintable.

Item	Available Size(s)	Pallet Count
TEC99211	12 - 16 oz. cans/case	(147 cases/pallet)



TEC99215

Rubber Treatment

Protects rubber from drying & becoming brittle. Also ideal for lifting polish marks from trim. Non-silicone.

Item	Available Size(s)	Pallet Count
TEC99215	12 - 10.5 oz. cans/case	(100 cases/pallet)



TEC99401

Trim Adhesive

Bonds many automotive materials including carpeting, light-weight headliners, plastics, rubber, etc. Features an Adjustable Actuator.

Item	Available Size(s)	Pallet Count
TEC99401	12 - 16.25 oz. cans/case	(64 cases/pallet)



TEC99418

Furniture Polish

For light or dark furniture, ceramic & plastic tile, leather articles, chrome, stainless steel, porcelain, brass, marble, vinyl & enameled surfaces. Leaves a dust free finish.

Item	Available Size(s)	Pallet Count
TEC99418	12 - 19 oz. cans/case	(100 cases/pallet)



TEC99419

Foaming Disinfectant Cleaner

The easy way to clean and deodorize. Formulated to act like a disinfectant. Spray, then wipe clean. Anti-bacterial formula great for nursery, home, hospitals and sick rooms.

Item	Available Size(s)	Pallet Count
TEC99419	12 - 19 oz. cans/case	(100 cases/pallet)



TEC99422

Salt Remover

Removes stubborn salt stains from any fabric quickly and easily. Great for use on carpets and mats around the house or in your vehicle. Built-in brush loosens salt. Inverted Fan Tip. *NOT FOR SALE IN CALIFORNIA*

Item	Available Size(s)	Pallet Count
TEC99422	12 - 11oz. cans/case	(100 cases/pallet)



TEC99430

TAK Floor Mat Adhesive

Creates a strong, yet temporary bond between carpet & carpet film. Will not transfer to fabric. Easily removed. Provides extra tack for the film to secure into place. Will work great in conjunction with our new TEC1337 or any of our DMR plastics.

Item	Available Size(s)	Pallet Count
TEC99430 1	2 - 14 oz. cans/case	(100 cases/pallet)

Refer to SDS before use



TEC99415

Chewing Gum Remover

Freezes gum, wax & latex paint for easy removal. Use on carpets, upholstery, wood, vinyl, paint, cloth, plastic & most other surfaces.

Item	Available Size(s)	Pallet Count
TEC99415	12 - 5.5 oz. cans/case	(100 cases/pallet)



AEROSOLS



Always wear recommended safety equipment



216060



Detail Xpress™ Glass Cleaner

This safe and easy to use cleaner dissolves smudges, film, scum, smears, bugs and other soil. Spray and wipe windows, mirrors and glass.

Item	Available Size(s)	Pallet Count
216060	12 - 19oz. cans/case	(100 cases/pallet)



216160



Detail Xpress™ Spotter Carpet

This is a powerful carpet stain & spot remover. Contains strong chemicals to remove stains due to dirt, grease, oil, mud, ketchup, vomit, urine, coffee, tea, alcoholic beverages, soft drinks & blood. Contains no solvents.

Item	Available Size(s)	Pallet Count
216160	12 - 18 oz. cans/case	(100 cases/pallet)



216260



Detail Xpress™ Foaming Upholstery Cleaner

This product is specially formulated to gently foam away soil, dirt & stains from velour, cloth, carpet & other similiar surfaces. Will not soak into fabric. Leaves the surface clean & dry. Inverted Fan Tip.

Item	Available Size(s)	Pallet Count
216260	12 - 19 oz. cans/case	(100 cases/pallet)



225960



Detail Xpress™ Interior Detailer

Matte finish protectant that penetrates into polycarbonate leaving a long lasting, waterproof shine. Just spray & walk away.

Item	Available Size(s)	Pallet Count
225960	12 - 10 oz. cans/case	(100 cases/pallet)



227660



Detail Xpress™ Spray Shine - Ultimate Cleaning Wax

Removes tar, bugs, tree sap and more. Excellent for all Painted Surfaces, Glass, Mirrors, Chrome, Stainless Steel, Aluminum, Fiberglass, Gel Coat Finishes and non-porous Plastics. (Avoid using on Seats, Dashboards, Vinyl Tops, Convertible Tops, Molding or Tires.).

Item	Available Size(s)	Pallet Count
227660	12 - 17.5 oz. cans/case	(100 cases/pallet)

AIR FRESHENERS

CLEANING PRODUCTS

Water-Based Water-Based Air Freshener - All Scents (below)

Available Size(s)



Technician's Choice® Water Based Air Fresheners...Long lasting fresh scent, while eliminating stale and musty air, it will also give a fresh scent to new or reconditioned cars.

- Biodegradable
- Long Lasting
- Water Soluble
- Will not stain carpets or floor mats

(12) 32 oz./case
(4) 1 gal./case



TEC50
Baby Powder

TEC53
Lemon

TEC54
Strawberry

TEC56
Fresh Air

TEC57
New Car

TEC59
Piña Colada

TEC60
Vanilla

TEC61
Leather

TEC64
Sweet Ozium



TEC517



WOW Fabric & Upholstery Freshener - Original

Available Size(s)

A blend of odor eliminators, special solubilizers & essential oils which eliminate odors. Leaves pleasant scent. Non-toxic.

TEC51716 (6) 16 oz./case
TEC51701 (4) 1 gal./case



TEC521



WOW Fabric & Upholstery Freshener - Fresh Air

Available Size(s)

A blend of odor eliminators, special solubilizers & essential oils which eliminate odors. Leaves pleasant scent. Non-toxic.

TEC52116 (6) 16 oz./case
TEC52101 (4) 1 gal./case



Odor Elimination pages 38-39

Refer to SDS before use

FRAGRANCES 100% OIL

CLEANING PRODUCTS

100% Oil Fragrances

Scents



Fragrances Unlimited®

100% Oil
2 oz. bottles
No clog sprayer
Available in glass or plastic

All scents available in:

(Each) 1 gal.
(120) 2 oz. bottles/tray
(12) 2 oz. bottles/case

One spray, lasts all day!

INSPIRED BY		POPULAR	
FRG68	<i>Escape</i>	FRG60	<i>Apple</i>
FRG32	<i>Eternity</i>	FRG55	<i>Baby Powder</i>
FRG72	<i>Egyptian Musk</i>	FRG30	<i>Black Gold</i>
FRG62	<i>Giorgio</i>	FRG10	<i>Boss</i>
FRG48	<i>Obsession</i>	FRG99	<i>Bubble Gum</i>
FRG28	<i>Polo</i>	FRG74	<i>Cool Breezzz</i>
FRG12	<i>Tommy</i>	FRG77	<i>Easy Money</i>
FRG42	<i>Tommy Girl</i>	FRG46	<i>Heart Break</i>
FRG36	<i>White Diamonds</i>	FRG83	<i>Lemon</i>
		FRG33	<i>Midnight Lace</i>
		FRG40	<i>Orange</i>
		FRG22	<i>Peach</i>
		FRG18	<i>Purple Passion</i>
		FRG44	<i>Rap</i>
		FRG24	<i>Strawberry</i>
		FRG14	<i>Watermelon</i>
		FRG37	<i>Wild Cherry</i>
		FRG38	<i>Yellow Gold</i>

DISPLAY KITS AVAILABLE (12 per display kit)



590160 *Fragrance Display 1 Best Seller*

Includes: Boss, Peach, Rap, Cool Breezzz

590260 *Fragrance Display 2 Best Seller*

Includes: Baby Powder, Wild Cherry, Watermelon, Purple Passion

5s to 55s - You will find the size to fit your needs!

Whether you are ordering bulk or individual, our variety of packaging sizes is sure to accommodate your needs!

Not sure what package size you need? Ask our customer service team!

Our industry trained experts are ready to assist you!

1-800-323-3521
Call Today!

Always wear recommended safety equipment



CLEANING PRODUCTS

All-Purpose / Multi-Purpose Cleaners

CLEANING PRODUCTS



TEC48

All Purpose Cleaner Original

CONCENTRATE. Use in engine compartments, tires, vinyl tops, vinyl and cloth interiors. Excellent for removing spots, bugs, grease, oil & dirt. Water based. Excellent hard water stability. Biodegradable. Dilute up to 1:6.

Available Size(s)

TEC4804 (4) 1 gal./case
TEC4805 5 gal./HP
TEC4815 15 gal./keg
TEC4855 55 gal./drum



TEC236

Magnifico

Multi-purpose cleaner designed to clean floors, walls, kitchens & bathrooms by penetrating deep into the surface to encapsulate dirt and grease. Leaves a long lasting fragrance with no residue. Biodegradable. Concentrate can be diluted up to 1:64 to achieve desired results on multiple surfaces. Lavender fragrance. Available in Bulk & RTU Formulas.

Available Size(s)

TEC23632CS (6) 32 oz./case
TEC23604 (4) 1 gal./case
TEC23605 5 gal./HP
TEC23615 15 gal./keg
TEC23655 55 gal./drum



TEC240/77

Green All Purpose Cleaner

CONCENTRATE. Cleans engines, tools, concrete, upholstery, vinyl, carpeting & more. Good for floor scrubbers. Water based. Use in hot or cold water. Excellent hard water stability. Biodegradable. Dilute up to 1:20. Pleasant fragrance.

Available Size(s)

TEC240/7704 (4) 1 gal./case
TEC240/7705 5 gal./HP
TEC240/7755 55 gal./drum



TEC249

Awesome Pink APC/Degreaser

TEC249 Awesome Pink All-Purpose Cleaner/Degreaser is designed to clean and degrease automotive engines, RV's, boats and motorcycles. TEC249 also works well as a wax stripper and for cleaning vinyl. It is safe on glass and trim making for an easy to use, time saving cleaner/degreaser formulated for a variety of uses. Biodegradable & hard water stable. Available in Bulk & RTU formulas.

Available Size(s)

TEC24932CS (6) 32 oz./case
TEC24904 (4) 1 gal./case
TEC24905 5 gal./HP
TEC24955 55 gal./drum



Refer to SDS before use



TEC319

Spray Cleaner



CONCENTRATE. Developed as a multi-purpose cleaner for removing grease, grime & other stubborn soils with spray-on, wipe-off ease. Use full strength for scuff marks, tile, brake dust, appliances, canvas awnings; dilute 1:8 for walls, woodwork, grease; dilute 1:3 for exhaust, aluminum, chrome, stainless steel. Excellent hard water stability and rinsing. Biodegradable. Fresh air fragrance.

Available Size(s)

- TEC31922CS (12) 22 oz./case
- TEC31904 (4) 1 gal./case
- TEC31905 5 gal./HP
- TEC31915 15 gal./keg
- TEC31955 55 gal./drum



TEC319G

Green Spray Cleaner



CONCENTRATE. Developed as a multi-purpose cleaner for removing grease, grime & other stubborn soils with spray-on, wipe-off ease. Use full strength for scuff marks, tile, brake dust, appliances, canvas awnings; dilute 1:8 for walls, woodwork, grease; dilute 1:3 for exhaust, aluminum, chrome, stainless steel. Excellent hard water stability and rinsing. Biodegradable. Fresh air fragrance.

Available Size(s)

- TEC319G22CS (12) 22 oz./case
- TEC319G04 (4) 1 gal./case
- TEC319G05 5 gal./HP
- TEC319G55 55 gal./drum



TEC320

Dissolve-All Citrus All Purpose Cleaner



CONCENTRATE. A blend of non-ionic detergents, water softeners, glycol ethers & citrus extract designed as a multi-purpose cleaner. Developed to remove tar & grease. May be used as carpet pre-spotter. Excellent hard water stability. Biodegradable. Dilute up to 1:6. Citrus fragrance.

Available Size(s)

- TEC32004 (4) 1 gal./case
- TEC32005 5 gal./HP
- TEC32015 15 gal./keg
- TEC32055 55 gal./drum



TEC322

Hot Stuff All Purpose Cleaner



CONCENTRATE. All purpose cleaner/degreaser will remove grease & grime from walls, concrete floors & all hard surface areas. No abrasives, phosphate free. Excellent hard water stability. Biodegradable. Dilute with water - 1:6 for engines, wheels, walls, doors & trucks; 1:12 for general cleaning.

Available Size(s)

- TEC32204 (4) 1 gal./case
- TEC32205 5 gal./HP
- TEC32255 55 gal./drum



TEC387

Orange Crush All Purpose Cleaner/Degreaser



CONCENTRATE. All purpose cleaner/degreaser that combines water miscible solvents, alkaline hydroxides & non-ionic detergents to remove grease & grime from any hard surface areas. No abrasives, phosphate free. Excellent hard water stability. Biodegradable. Dilute up to 1:1 to 1:50. Citrus fragrance.

Available Size(s)

- TEC38704 (4) 1 gal./case
- TEC38705 5 gal./HP
- TEC38715 15 gal./keg
- TEC38730 30 gal./drum
- TEC38755 55 gal./drum



TEC399

Sani-Tec Detergent/Deodorizer



Designed to clean & deodorize floors, walls, bathrooms, ceramic tile, shower stalls, cabinets, tables & other porous & non-porous surfaces. May be applied with a mop, cloth, sponge or hand held trigger sprayer. Biodegradable. For light cleaning, dilute 1:32. For heavy cleaning, dilute 1:16. Fresh fragrance.

Available Size(s)

- TEC39904 (4) 1 gal./case
- TEC39905 5 gal./HP

Always wear recommended safety equipment



All-Purpose / Multi-Purpose Cleaners



TEC459 2-Hot Stuff



CONCENTRATE. Economical cleaner/degreaser cleans engines, tires, hard surface areas, vinyl/upholstery, carpets & more. Use in hot or cold water. Excellent hard water stability. Biodegradable. Safe on aluminum. Dilute 1:4 to 1:10 for floors. Dilute 1:3 for general purpose cleaning. Dilute 1:1 for heavy duty cleaning. Cinnamon fragrance.

Available Size(s)

TEC45904	(4) 1 gal./case
TEC45905	5 gal./HP
TEC45915	15 gal./keg
TEC45930	30 gal./drum
TEC45955	55 gal./drum



TEC460 Purpose Multi-Purpose Cleaner



HYPER CONCENTRATE. Designed to clean engines, door jambs, wheels, tires, vinyl, carpet, upholstery, floors & more. Excellent hard water stability. Biodegradable. For 1 gallon: 1:4 for first dilution. For 5 & 55 gallon: 1:10 for first dilution. After mixing hyper concentrate, can be further diluted up to 1:20.

Available Size(s)

TEC46004	(4) 1 gal./case
TEC46005	5 gal./HP
TEC46055	55 gal./drum

1 Gallon makes 5 Gallons
5 Gallons makes 55 Gallons
55 Gallons makes 605 Gallons



TEC460D Purpose Multi-Purpose Cleaner



CONCENTRATE. Designed to clean engines, door jambs, wheels, tires, vinyl, carpet, upholstery, floors & more. Excellent hard water stability. Biodegradable. Dilute 1:1 for heavy duty cleaning; 1:4 for general purpose cleaning.

Available Size(s)

TEC460D55	55 gal./drum
-----------	--------------



TEC461 Big Red All Purpose Cleaner



CONCENTRATE. Economical cleaner/degreaser cleans engines, tires, hard surface areas, vinyl/upholstery, carpets & more. Use in hot or cold water. Excellent hard water stability. Biodegradable. Safe on aluminum. Dilute 1:4 to 1:10 for floors. Dilute 1:3 for general purpose cleaning. Dilute 1:1 for heavy duty cleaning. Cinnamon fragrance.

Available Size(s)

TEC46104	(4) 1 gal./case
TEC46105	5 gal./HP
TEC46115	15 gal./keg
TEC46130	30 gal./drum
TEC46155	55 gal./drum



TEC462 Dyn-O-Mite All Purpose Cleaner



CONCENTRATE. Developed to effectively clean engines, tires, hard surface areas, vinyl, upholstery & carpets. No white residue on rubber hoses. Safe on non-ferrous metals. Excellent hard water stability. Use in hot and cold water. Contains no sodium hydroxide. Biodegradable. Dilution: 1:1 for heavy duty cleaning; 1:4 to 1:8 for general cleaning; 1:16 for floors. Cinnamon fragrance.

Available Size(s)

TEC46204	(4) 1 gal./case
TEC46205	5 gal./HP
TEC46215	15 gal./keg
TEC46230	30 gal./drum
TEC46255	55 gal./drum

Refer to SDS before use



TEC462D

Dyn-O-Mite All Purpose Cleaner D



Developed to effectively clean engines, tires, hard surface areas, vinyl, upholstery & carpets. No white residue on rubber hoses. Safe on non-ferrous metals. Excellent hard water stability. Use in hot & cold water. Contains no sodium hydroxide. Biodegradable. Dilution: 1:1 for heavy duty cleaning; 1:4 for general cleaning. Cinnamon fragrance

Available Size(s)

- TEC462D05 5 gal./HP
- TEC462D55 55 gal./drum



TEC464S

Superb Purple Cleaner/Degreaser



CONCENTRATE. For tough jobs. Use on engine compartments, tires, vinyl tops & cloth interior. Excellent spot & bug remover. Also useful on grease, oil & dirt. Water based with excellent hard water stability. Biodegradable. Dilute up to 1:3-1:6 for engines, 1:8 for vinyl & cloth interiors.

Available Size(s)

- TEC464S32CS (12) 32 oz./case
- TEC464S04 (4) 1 gal./case
- TEC464S05 5 gal./HP
- TEC464S15 15 gal./keg
- TEC464S30 30 gal./drum
- TEC464S55 55 gal./drum



TEC468

Superb Blue Cleaner/Degreaser



CONCENTRATE. An industrial cleaner & degreaser designed to remove dirt, grease & oil from all types of hard surfaces. Contains a blend of grease cutting detergents, water miscible solvents & water softening agents. Phosphate free, biodegradable & economical to use. Excellent hard water stability. Heavy soiled surfaces use full strength. Dilute up to 1:10-1:20. Citrus fragrance.

Available Size(s)

- TEC46804 (4) 1 gal./case
- TEC46805 5 gal./HP
- TEC46815 15 gal./keg
- TEC46830 30 gal./drum
- TEC46855 55 gal./drum



TEC469

Deep Purple Heavy Duty All Purpose Cleaner



CONCENTRATE. A low sudsing, industrial strength all purpose cleaner/degreaser for nearly every application which removes dirt, grease, oil & tar. This powerful cleaner/degreaser easily separates, entraps & removes grease, dirt, oil & grime from almost every type of surface. Non-flammable & non-abrasive, water based & biodegradable. Gets the job done on auto tires, engines and interiors. Excellent hard water stability. Dilute 1:1 for heavy duty cleaning; 1:8-1:16 for light duty cleaning. Grape fragrance.

Available Size(s)

- TEC46904 (4) 1 gal./case
- TEC46905 5 gal./HP
- TEC46915 15 gal./keg
- TEC46930 30 gal./drum
- TEC46955 55 gal./drum



TEC475

Superb Green



CONCENTRATE. Developed to effectively clean automotive interiors, tires, motors, truck bodies & industrial equipment. Janitorial application would include floors, kitchens and bathrooms. D-limonene based professional strength, no harsh chemicals. Biodegradable. Excellent hard water stability. Dilute up to 1:20. Citrus fragrance.

Available Size(s)

- TEC47504 (4) 1 gal./case
- TEC47505 5 gal./HP
- TEC47515 15 gal./keg
- TEC47530 30 gal./drum
- TEC47555 55 gal./drum



TEC479

Superb Red



CONCENTRATE. Blend of water miscible solvents, water softening agents & surface active agents designed for maximum cleaning & degreasing efficiency. May be used to clean concrete surfaces, truck bodies, industrial equipment, automotive engines & all hard surfaces. Hot or cold water. Biodegradable. No abrasives. Excellent hard water stability. Dilute 1:8 cleaning; 1:16 degreasing.

Available Size(s)

- TEC47904 (4) 1 gal./case
- TEC47905 5 gal./HP
- TEC47915 15 gal./keg
- TEC47930 30 gal./drum
- TEC47955 55 gal./drum

Always wear recommended safety equipment

CLEANING PRODUCTS

CLEANING PRODUCTS

All-Purpose / Multi-Purpose Cleaners



TEC487



Firewater All Purpose Cleaner

HYPER CONCENTRATE. Designed to clean wheels, tires, vinyl, carpet, upholstery, floors, door jambs & engines. Biodegradable. Excellent hard water stability. Hyper concentrate, dilute 1:11; further diluted up to 1:20 as a concentrate.

Available Size(s)

TEC48705 5 gal./HP
TEC48755 55 gal./drum

5 Gallons makes 55 Gallons
55 Gallons makes 605 Gallons



TEC650



Express Cool Blue All Purpose Cleaner

CONCENTRATE. Easily removes grease, grime & stubborn dirt. Works great on vinyl, rubber, plastic, carpet stains, floors & engines. Biogradable. Dilute up to 1:6.

Available Size(s)

TEC65005 5 gal./HP
TEC65055 55 gal./drum



TEC651



Express Citromax Citrus Cleaner

CONCENTRATE. All purpose cleaner that removes grease & grime from any hard surface. Biodegradable. Dilute up to 1:20. Citrus fragrance.

Available Size(s)

TEC65105 5 gal./HP
TEC65155 55 gal./drum



TEC726



All Purpose Heavy Duty Cleaner

SUPER CONCENTRATE. Blend of detergents, alkali builders, glycol ethers & water softening agents designed for use in bulk storage systems for the removal of light to heavy soils from porous & non-porous surfaces. Phosphate Free. Economical to use. Biodegradable. Excellent hard water stability. Dilutions: Heavy Duty 1:8; Medium Duty 1:16; Light Duty 1:32.

Available Size(s)

TEC72604 (4) 1 gal./case
TEC72605 5 gal./HP
TEC72615 15 gal./keg
TEC72655 55 gal./drum



Refer to SDS before use



Tunnel



In-Bay Automatic



Self-Service

If you want to deliver the cleanest and driest vehicles in the industry -
Take your customers Platinum!TM



For a complete list of our products, see the
Platinum Professional Car Wash Systems[®] Catalog,
now included in this book (begins on pg. 110)
or visit us online at
www.platinumcw.net



PLATINUM
PROFESSIONAL CAR WASH SYSTEMS[®]

Our customer service team is ready to help you call **1-800-323-3521** today!

Always wear recommended safety equipment

CLEANING PRODUCTS

CLEANING PRODUCTS

Car Wash

CONCENTRATED



TEC200/98

Suds to the Ceiling

CONCENTRATE. Formulated thick for hand or automated car washes. Rich, long-lasting lather. Excellent rinsing & lubricity. Excellent hard water stability. Lower wipe down time. Gloss finish. Biodegradable. Dilute 1:320. Cherry fragrance.

Available Size(s)

TEC200/9804	(4) 1 gal./case
TEC200/9805	5 gal./HP
TEC200/9815	15 gal./keg
TEC200/9830	30 gal./drum
TEC200/9855	55 gal./drum



TEC207

Purplicious Car Wash

CONCENTRATE. Thick formula that produces a high foam & rich long lasting lather with excellent lubricity that offers easy rinsing & less wipe down time. Excellent hard water stability. Phosphate free and biodegradable. Dilute 2 oz. per 5 gallon pail (1:320). Grape fragrance.

Available Size(s)

TEC20704	(4) 1 gal./case
TEC20705	5 gal./HP
TEC20715	15 gal./keg
TEC20730	30 gal./drum
TEC20755	55 gal./drum



TEC208

Blue Stuff

CONCENTRATE. Formulated to be a great price point with some body! Perfect for the a bucket wash & still thin enough to meter. Loaded with grease cutting detergent, foam boosters & water softening agents; the perfect addition to your vehicle care needs! Formulated to work in hard water. Phosphate free and biodegradable. Dilute 2-4 oz. per 5 gallon pail (1:320-1:160). Cherry fragrance.

Available Size(s)

TEC20804	(4) 1 gal./case
TEC20805	5 gal./HP
TEC20815	15 gal./keg
TEC20830	30 gal./drum
TEC20855	55 gal./drum



TEC237

Truck Wash

CONCENTRATE. Part of our Heavy Duty & Fleet Maintenance category, this product is designed to clean polished aluminum, painted surfaces, truck exhaust deposits, road film & bug residue from the roads most seasoned vehicles. Dilute 1:25 to 1:64 for hand washing. Biodegradable. Dilute 1:100 for pressure washing.

Available Size(s)

TEC23704	(4) 1 gal./case
TEC23705	5 gal./HP
TEC23715	15 gal./keg
TEC23730	30 gal./drum
TEC23755	55 gal./drum



TEC470D

Ultimate Car Wash D

CONCENTRATE. Excellent cleaning with foam & hard water stability at an economical price. Dilute up to 1:100. Biodegradable. Sassafras fragrance.

Available Size(s)

TEC470D05	5 gal./HP
TEC470D55	55 gal./drum

Refer to SDS before use

CLEANING PRODUCTS

CONCENTRATED - CONTINUED

SUPER CONCENTRATED

HYPER CONCENTRATED



TEC477
Green Apple Car Wash



CONCENTRATE. A blend of detergents, foaming and water softening agents developed to maximize foam stability during the hand washing process. Can also be used with automatic systems. Excellent hard water stability. Biodegradable. Dilute up to 1:320. Green apple fragrance.

Available Size(s)

- TEC47704 (4) 1 gal./case
- TEC47705 5 gal./HP
- TEC47755 55 gal./drum



TEC484
Blue Car Wash



CONCENTRATE. Fortified with grease cutting detergents, foam boosters & water softening agents. Use in hard or soft water. Excellent hard water stability. Phosphate free. Dilute 1:320. Cherry fragrance.

Available Size(s)

- TEC48404 (4) 1 gal./case
- TEC48405 5 gal./HP
- TEC48415 15 gal./keg
- TEC48430 30 gal./drum
- TEC48455 55 gal./drum



TEC653
Express Strawberry Swirl



CONCENTRATE. Car wash formulated thick for hand or automatic car washes. Produces a rich, long-lasting lather that rinses easily & reduces wipe down time. Easily removes dirt, grease, grime & dust. Biodegradable. Dilute up to 1:128. Strawberry fragrance.

Available Size(s)

- TEC65305 5 gal./HP
- TEC65355 55 gal./drum



TEC206
Super Suds Car Wash



SUPER CONCENTRATE. Formulated thin for hand or automated car washes. Excellent rinsing, lower wipe down time. Great hard water stability, works with metering devices. Rich, long-lasting lather, gloss finish. Biodegradable. Dilute 1:640. Fresh air fragrance.

Available Size(s)

- TEC20604 (4) 1 gal./case
- TEC20605 5 gal./HP
- TEC20615 15 gal./keg
- TEC20655 55 gal./drum



TEC471
Thick & Blue Car Wash



SUPER CONCENTRATE. Our thickest formula fortified, with grease cutting detergents, foam boosters & water-softening agents. Excellent hard water stability. Use in hard or soft water. Non-toxic. Phosphate free. Biodegradable. Dilute up to 1:640. Cherry fragrance.

Available Size(s)

- TEC47104 (4) 1 gal./case
- TEC47105 5 gal./HP
- TEC47130 30 gal./drum
- TEC47155 55 gal./drum



TEC470
Ultimate Car Wash



HYPER CONCENTRATE. Excellent cleaning power & sudsing action. Rinses clean, no film. Excellent hard water stability. For 1 gallon: 1:4 for first dilution. For 5 & 55 gallon: 1:11 for first dilution. Dilute up to 1:100 after mixing hyper concentrate. Sassafras fragrance.

Available Size(s)

- TEC47004 (4) 1 gal./case
- TEC47005 5 gal./HP
- TEC47055 55 gal./drum

1 Gallon makes 5 Gallons
5 Gallons makes 55 Gallons
55 Gallons makes 605 Gallons



Always wear recommended safety equipment



Car Wash

WASH & WAX



TEC472



Grape & Glow Car Wash

CONCENTRATE. High performance, thick car wash - leaves a "just waxed" look. High gloss. Excellent beading. High sudsing action. Makes for fast drying & quick wipe down time. Works with metering devices. Excellent hard water stability. Rich, long-lasting lather. Biodegradable. Dilute up to 1:200. Grape fragrance.

Available Size(s)

TEC47204 (4) 1 gal./case
 TEC47205 5 gal./HP
 TEC47215 15 gal./keg
 TEC47230 30 gal./drum
 TEC47255 55 gal./drum



TEC652



Express Green Suds Wash & Wax

CONCENTRATE. Car wash soap with great foam that leaves a "just waxed" look. Rinses easily & leaves no residue. Produces a rich, long-lasting lather that rinses easily & lower wipe down time. Easily removes dirt, grease, grime & dust. Lime fragrance. Biodegradable. Dilute up to 1:128.

Available Size(s)

TEC65205 5 gal./HP
 TEC65255 55 gal./drum



TEC725



Wash n Wax Car Wash

CONCENTRATE. Blend of non-ionic detergents, foam boosters and wax like surface active agents designed to give excellent car washing results, excellent gloss combined with excellent sheeting action. High foaming action. Great hard water stability. Formulated to easily pull through a metering device. Biodegradable. Dilute up to 1:200. Cherry fragrance.

Available Size(s)

TEC72504 (4) 1 gal./case
 TEC72505 5 gal./HP
 TEC72515 15 gal./keg
 TEC72530 30 gal./drum
 TEC72555 55 gal./drum

Need car wash supplies?

Aqua-Foamer on page 105
Wash Brushes on page 102
Wash & Dry supplies pages 106-107



Refer to SDS before use



TEC490

Powdered Blue Auto Shampoo

CONCENTRATE. Fully dispersible powder. For manual washing. Excellent hard water stability, leaves no film. Long lasting suds. Clean fragrance. Dilute up to 1/4 oz. per gallon (1:512).

Available Size(s)

- TEC49035 35 lb. drum
- TEC490100 100 lb. drum
- TEC490300 300 lb. drum



TEC493

Powdered Auto Shampoo

CONCENTRATE. Fully dispersible powder, strongest available. For manual washing. Excellent hard water stability, leaves no film. Long lasting suds, rinses easily. Dilute up to 1/8 oz. per gallon (1:1000).

Available Size(s)

- TEC49335 35 lb. drum



TEC209

Waterless Car Wash

Go green with Waterless Car Wash! With water bans & restrictions becoming more commonplace, this is a "must have" product that will allow you to save time, money & WATER. A spray on, wipe off formula makes application a breeze. With a hand car wash averaging anywhere from 20-100 gallons of water per wash, it is now, more than ever, the right time to try & conserve water. Contains ingredients to lift away dirt & grime in every attempt to reduce scratches. Grape fragrance.

Available Size(s)

- TEC20932CS (6) 32 oz./case
- TEC209604 (4) 1 gal./case
- TEC20905 5 gal./HP



CLEANING PRODUCTS

POWDERED

WATERLESS



Always wear recommended safety equipment



CLEANING PRODUCTS

Floor Cleaners

CLEANING PRODUCTS



TEC324



Happy Medium Floor Cleaner

A blend of low foaming detergents & water softening agents designed to remove surface dust or dirt without any damage to floor coatings, natural or synthetic surfaces. Removes surface dirt from vinyl tile, ceramic & marble without any deleterious effects. No butyl cellosolve or harsh alkalis. Contains no phosphates, pH controlled & biodegradable. Economical to use. Dilute 1:8 for surface dirt; 1:16 for automatic equipment. Pine fragrance.

Available Size(s)

TEC32404 (4) 1 gal./case
TEC32405 5 gal./HP
TEC32455 55 gal./drum



TEC360/49



Heavy Duty Floor Cleaner

For all types of dirt, oil & grease. Use as degreaser for industrial floor scrubbing machinery. Biodegradable. Dilute up to 1:8.

Available Size(s)

TEC360/4904 (4) 1 gal./case
TEC360/4905 5 gal./HP
TEC360/4915 15 gal./keg
TEC360/4955 55 gal./drum



TEC381



Superb Floor Cleaner

CONCENTRATE. Floor cleaner and degreaser is designed to remove grease & dirt from any washable surface. Biodegradable. Dilute 1:1 grills; 1:4 kitchen for counters; 1:8 for carpet spot cleaning; 1:16 for no-wax floors. Lemon fragrance.

Available Size(s)

TEC38104 (4) 1 gal./case
TEC38105 5 gal./HP
TEC38115 15 gal./keg
TEC38155 55 gal./drum



TEC389



A-1 Industrial Strength Floor Cleaner Concentrate

CONCENTRATE. An industrial strength floor cleaner for use with mop applications and for automatic scrubbing equipment. Concentrated blend of detergents, glycol ethers, inorganic salts & water softening agents. Excellent freeze/thaw & heat stability. This product will not clog filters. Biodegradable. Dilute up to 1:8; for automatic equipment: 1 gal : 20 gal warm water.

Available Size(s)

TEC38905 5 gal./HP
TEC38955 55 gal./drum



TEC466



DV-US Lemon Floor Cleaner

Cleaner/degreaser for hard surfaces. Maximizes cleaning & degreasing efficiency. Biodegradable. Dilute for automatic equipment - 1 gal : 20 gal water. Lemon fragrance.

Available Size(s)

TEC46604 (4) 1 gal./case
TEC46605 5 gal./HP
TEC46630 30 gal./drum
TEC46655 55 gal./drum

Refer to SDS before use



TEC492

Powdered Orange Concrete Floor Cleaner

Cleans grease, oil, tire marks, road grime & more. Orange powder turns green. Dilute 4-6oz of powder per gallon of water. Pine fragrance.

Available Size(s)

- TEC49235 35 lb. drum
- TEC49250 50 lb. drum
- TEC492100 100 lb. drum
- TEC492300 300 lb. drum



TEC494

Powdered White Concrete Floor Cleaner

Cleans dirt, grease, oil stains & greasy build-up. White powder stays white. Dilute 4-6oz per gallon. Pine fragrance.

Available Size(s)

- TEC494100 100 lb. drum



Pressure Washer - page 57

CLEANING PRODUCTS

CLEANING PRODUCTS

Glass Cleaners



TEC83



Industrial Glass Cleaner RTU

Industrial strength glass cleaner delivers results without leaving streaks. Cuts through smoke film & bugs. Biodegradable.

Available Size(s)

TEC8304 (4) 1 gal./case
TEC8305 5 gal./HP
TEC8315 15 gal./keg
TEC8355 55 gal./drum



TEC250



Glass Cleaner

CONCENTRATE. Lightly ammoniated glass cleaner concentrate that is a blend of water miscible solvents & wetting agents & ammonia. Dissolves both tobacco & smoke residue & the film deposited on glass from the oxidation of vinyl. Contains no abrasives. Non-streaking. Biodegradable. Dilute up to 1:4.

Available Size(s)

TEC25004 (4) 1 gal./case
TEC25005 5 gal./HP
TEC25055 55 gal./drum



TEC254



Vision Glass Cleaner RTU

Our most popular ammonia free cleaner. Cuts through smoke residue & film deposited on glass from oxidation of vinyl. Non-abrasive. Leaves no streaks. Works quickly. Biodegradable.

Available Size(s)

TEC25404 (4) 1 gal./case
TEC25405 5 gal./HP
TEC25415 15 gal./keg
TEC25455 55 gal./drum



TEC255



Citrus Vision Glass Cleaner

CONCENTRATE. Ammonia free cleaner. Cuts through smoke residue, grease & film deposited on glass from oxidation of vinyl. Non-abrasive. Leaves no streaks. Works quickly. Biodegradable. Dilute up to 1:6. Citrus fragrance.

Available Size(s)

TEC25504 (4) 1 gal./case
TEC25505 5 gal./HP
TEC25515 15 gal./keg
TEC25530 30 gal./drum
TEC25555 55 gal./drum



Unable to find what you need?
Call our customer service at 1-800-323-3521!



Refer to SDS before use



TEC480
Vision Glass Cleaner



HYPER CONCENTRATE. Ammonia free formula cuts through smoke residue & film. Streakless. Biodegradable. 1 gallon makes 5 gallons. 5 gallons makes 55 gallons.

Available Size(s)

- TEC48004 (4) 1 gal./case
- TEC48005 5 gal./HP

1 Gallon makes 5 Gallons
5 Gallons makes 55 Gallons



CLEANING PRODUCTS



TEC481
Pink Heavy Duty Glass Cleaner



CONCENTRATE. Our strongest ammonia formula cleaner. Removes window tint film adhesive. No streak formula. Biodegradable. Dilute up to 1:11.

Available Size(s)

- TEC48104 (4) 1 gal./case
- TEC48105 5 gal./HP
- TEC48115 15 gal./keg
- TEC48155 55 gal./drum



Aerosol Glass Cleaners - page 8
Microfiber cloths - page 107

Always wear recommended safety equipment



CLEANING PRODUCTS

Hand Cleaners

CLEANING PRODUCTS



TEC125



HD Citrus Hand Cleaner with Fine Pumice

Available Size(s)

Natural citrus cleansing agent dissolves grease, paints, inks & hard to remove soils. Five skin conditioners help to keep hands soft and smooth. Biodegradable. Citrus fragrance.

TEC12504 (4) 4-liter case



TEC127



Blue Velvet Skin Care Hand & Body Soap

Available Size(s)

Eliminates bar soap mess. Lightly scented liquid soap with with aloe vera, glycerin, vitamin E, jojoba & wheat germ extract. Solvent free. Biodegradable. Floral fragrance.

TEC12704 (4) 4-liter case



TEC128



Knock-Out HD Hand Soap with Scrubbing Beads

Available Size(s)

Micro-scrubbing beads aid in removing grease, water-based paints, ink & other hard to remove soils. Contains nine skin conditioners. Solvent free. Biodegradable. Floral fragrance.

TEC12804 (4) 4-liter case



TEC130



Cherry Blast HD Hand Soap

Available Size(s)

Remove grease, water-based paints, ink & other hard to remove soils. Contains five skin conditioners with fine pumice. Biodegradable. Cherry fragrance.

TEC13004 (4) 4-liter case



TEC135



Nutty Butter Heavy Duty Hand Soap with Walnut Shells

Available Size(s)

Easily removes heavy industrial soiling and conditions the skin, leaving hands smooth and supple. Premium, solvent-free cleansing agents combine with natural walnut shell scrubbers to safely and effectively remove dirt, grease, lubricants, diesel, brake fluid, cement, rust and many other hard to remove soils.

TEC13504 (4) 4-liter case



TEC124

Hand Cleaner Dispenser

Available Size(s)

Works for TEC125, TEC127, TEC128, TEC130 & TEC135. Includes dispenser reservoir & mounting plate for use with 4000ml refill tanks. Stay clean back dispenser with see-through white refill tank & reservoir.

TEC124 Each

Refer to SDS before use



TEC129



Handi Wipes Hand Cleaner Towels

Convenient hand cleaner/wipe combination. Removes tar, ink, paint & many other hard to remove soils. Contains five skin conditioners. Light citrus fragrance.

Available Size(s)

TEC12902 (2) 8# containers/case



TEC131



Super Strength Scrubber Towels

Hand cleaner/wipe combination that removes grease, tar, ink, paint & many other hard to remove soils. Heavy duty, dual texture towel absorbs soils from your hands & other surfaces & keeps them suspended for easy removal. Light citrus fragrance.

Available Size(s)

TEC13102 (2) 8# containers/case



TEC134



Eco-Soap Foaming Hand Soap

Technician's Choice® TEC134 Foaming Hand Soap is a mild liquid soap made from the finest ingredients available. It is formulated with vegetable derived emulsifiers, foaming agents and emollients. These ingredients are biodegradable as per OECD301.

Available Size(s)

TEC13416 (6) 16 oz./case



TEC133

Sani-Touch Hand Sanitizer & Conditioner

Waterless formula that sanitizes hands & kills up to 99.99% of many common possible disease causing germs & bacteria in as little as 15 seconds. Dries quickly, hands feels clean, soothed & moisturized. Fortified with Aloe Vera. Passion Fruit fragrance.

Available Size(s)

TEC133CS (16) 15 oz./case



TEC136

Sani-Touch Premium Gel Hand Sanitizer

For hand washing to decrease bacteria on the skin. Leaves hands feeling soft and smooth with Aloe and other botanicals. Helps reduce bacteria on the skin that could cause disease. Kills 99.99% of most common germs that may make you sick. Leaves no residue or stickiness.

Available Size(s)

TEC13604 (4) 1 gal./case



CLEANING PRODUCTS

Interior Cleaners

CLEANING PRODUCTS



TEC78

Blue Upholstery Shampoo



CONCENTRATE. Blue Upholstery Shampoo is formulated for use on all vinyl, fabrics, carpeting & vinyl tops. Easily removes stains, soil & dirt. Excellent hard water & foam stability. Dries to a powder, vacuum away. pH controlled. Protects against mildew. Non-toxic. Non-flammable. Biodegradable. Dilute 4-8 oz. to 1 gallon water. Citrus fragrance.

Available Size(s)

TEC7804 (4) 1 gal./case
TEC7805 5 gal./HP
TEC7815 15 gal./keg
TEC7855 55 gal./drum



TEC230

Upholstery Shampoo



CONCENTRATE. Industrial strength. Removes oil & water-based stains. Long-lasting suds. Ideal for hand shampooing. Non-toxic. Biodegradable. Works great in the Foam-A-Nator (pg. 59). Dilute up 2-4 oz. per gallon of water. Grape fragrance.

Available Size(s)

TEC23004 (4) 1 gal./case
TEC23005 5 gal./HP
TEC23055 55 gal./drum



TEC231

Carpet & Upholstery Extractor Shampoo with Anti-Scaler



CONCENTRATE. TEC231 Carpet & Upholstery Extractor Shampoo with Anti-Scaler offers all the same benefits of TEC232 with a keep clean anti-scaler. TEC231 Carpet & Upholstery Extractor Shampoo with Anti-Scaler is designed for use in all carpet extractor machines. TEC231 is a phosphate free, low foaming detergent which does not leave a soapy residue behind. TEC231 works with hot and cold water. TEC231 is a carpet and upholstery shampoo PLUS it also helps clean your extractor clean when used regularly. It also reduces and prevents the scale build up throughout the machine. Biodegradable. If you need to remove scale from a machine please see our TEC243 Anti-Scaler (pg. 40).

Available Size(s)

TEC23104 (4) 1 gal./case
TEC23105 5 gal./HP



TEC232

Carpet & Upholstery Extractor Shampoo



CONCENTRATE. Dry film, leaves no sticky residue. Low sudsing & water softening. For use in hot or cold water. Dilute 2 oz. to 1 gallon of water. Use with an extractor, the Do-All system or by hand. Fresh fragrance.

Available Size(s)

TEC23204 (4) 1 gal./case
TEC23205 5 gal./HP
TEC23255 55 gal./drum



TEC233

Take It Out (T.I.O.) Fabric Cleaner/Protectant RTU



Excellent fabric cleaner and protectant. Gentle enough to use on man-made fabrics. (i.e. Yes Essentials). Use with the Do-All system or by hand.

Available Size(s)

TEC23304 (4) 1 gal./case
TEC23305 5 gal./HP
TEC23315 15 gal./keg
TEC23355 55 gal./drum

Refer to SDS before use



TEC391
Do All Enzyme Cleaner



CONCENTRATE. Dry film, leaves no sticky residue. Low sudsing & water softening. Use in hot or cold water. Use with an extractor, the Do-All system or by hand. Use on hard or soft surfaces. For best results use in Tornador® (pg. 58). Dilute 1 oz. to 1 gallon of water. Fresh fragrance.

Available Size(s)

- TEC39104 (4) 1 gal./case
- TEC39105 5 gal./HP
- TEC39115 15 gal./keg
- TEC39155 55 gal./drum



TEC392
Heavy Duty Enzyme Spot & Stain Remover



CONCENTRATE. Dry film, leaves no sticky residue. Low sudsing & water softening. Use in hot or cold water. Use with an extractor, the Do-All system or by hand. Use on hard or soft surfaces. For best results use in Tornador® (pg. 58). Dilute 1:4 to 1:8 parts per quart. Fresh fragrance.

Available Size(s)

- TEC39204 (4) 1 gal./case
- TEC39205 5 gal./HP
- TEC39215 15 gal./keg
- TEC39230 30 gal./drum
- TEC39255 55 gal./drum



TEC265
Plastic Cleaner



Sure to restore the shine to any plastic surface. This product will also safely & effectively remove stains, cloudiness, dirt & streaks from plastic areas. Biodegradable.

Available Size(s)

- TEC26516CS (6) 16 oz./case
- TEC26504 (4) 1 gal./case
- TEC26505 5 gal./HP
- TEC26515 15 gal./keg
- TEC26530 30 gal./drum
- TEC26555 55 gal./drum



TEC419
One & Done™ Interior Cleaner & Conditioner RTU



A pH balanced, water based cleaner & conditioner which quickly removes trapped dirt & residue from leather, vinyl & plastic surfaces. Simply dampen a sponge or knit pad & spray a small amount of TEC419 on the applicator and work into the surface. Allow to set for a few minutes, then just wipe with a clean, soft, dry cloth - and you are done! A great time & labor saver - two products in one! Matte finish. Biodegradable.

Available Size(s)

- TEC41932CS (6) 32 oz./case
- TEC41904 (4) 1 gal./case
- TEC41905 5 gal./HP



TEC260
Leather Cleaner RTU



Deep cleans, restores & lubricates leather to return to its original luster. Phosphate free, pH balanced. Excellent for cleaning oil & water based stains.

Available Size(s)

- TEC26016 (6) 16 oz./case
- TEC26004 (4) 1 gal./case
- TEC26005 5 gal./HP



TEC440
Leather Conditioner



Lanolin based conditioner penetrates quickly to leave leather soft & supple. Restores natural look. Leather fragrance.

Available Size(s)

- TEC44016 (6) 16 oz./case
- TEC44004 (4) 1 gal./case

Always wear recommended safety equipment



CLEANING PRODUCTS

Janitorial & Disinfectants

CLEANING PRODUCTS



JTEC78

Carpet & Upholstery Shampoo

CONCENTRATE. Water-based, multi-purpose carpet cleaner formulated with cost & performance in mind. Biodegradable. Dilute up to 1:10. Citrus fragrance.

Item	Available Size(s)
JTEC7822CS	(12) 22 oz./case



JTEC801

Citrus All-Purpose Cleaner

For quick clean up on any washable surface. Great on grease. Biodegradable. Citrus fragrance.

Item	Available Size(s)
JTEC80122CS	(12) 22 oz./case



JTEC254

Janitorial Glass Cleaner

Our most popular ammonia free cleaner. Cuts through smoke residue & film deposits on glass. Works quickly, non-abrasive. Leaves no streaks. Biodegradable.

Item	Available Size(s)
JTEC25422CS	(12) 22 oz./case



JTEC804

Clean Shower Tub & Tile Cleaner

For quick clean up of tile & bathroom fixtures. Biodegradable. Fresh air fragrance.

Item	Available Size(s)
JTEC80422CS	(12) 22 oz./case



JTEC464

Superb Purple All-Purpose Cleaner

For quick clean-up on walls, floors & most non-porous surfaces. Removes fingerprints, grease & more. Biodegradable.

Item	Available Size(s)
JTEC46422CS	(12) 22 oz./case



JTEC806

Green Floor Cleaner

For light to heavy cleaning of floors & walls. Works great on concrete. Phosphate free. Biodegradable. Pine fragrance.

Item	Available Size(s)
JTEC80622CS	(12) 22 oz./case



JTEC800

Laundry Detergent

Tough on dirt & safe for colors. For use in hot or cold water. Biodegradable. Fresh fragrance. See also TEC800 on page 41 for additional sizes.

Item	Available Size(s)
JTEC80020CS	(12) 20 oz./case



JTEC807

Non-Acid Toilet Bowl Cleaner

Cleans & freshens. Safe for porcelain. Biodegradable. Fresh fragrance.

Item	Available Size(s)
JTEC80722CS	(12) 22 oz./case

Refer to SDS before use



JTEC808

Acid Toilet Bowl Cleaner

Best for stubborn stains. Cleans & freshens. Biodegradable. Wintergreen fragrance.

Item	Available Size(s)
JTEC80822CS	(12) 22 oz./case



JTEC809

Sparkling Clean Dishwashing Soap

Long lasting suds. Advanced grease cutting formula removes tough foods & leaves dishes sparkling. Biodegradable. Berry fragrance.

Item	Available Size(s)
JTEC80922CS	(12) 22 oz./case



Always wear recommended safety equipment

DISINFECTING PRODUCTS



ECP10

H₂O₂ Disinfectant/Cleaner

CONCENTRATE. The total solution for disinfecting facilities, dealerships and vehicles!

ECP10 H₂O₂ Disinfectant/Cleaner, when used as directed as a disinfectant is effective against: (product dwell time may vary based on targeted virus) Norovirus, Pseudomonis Aeruginosa, Staphylococcus Aureus, Salmonella Enterica, Streptococcus Pneumoniae, Escherichia Coli, Staphylococcus Aureus MRSA, Staphylococcus CA-MRSA (USA400), and Feline Calicivirus.

ACCORDING TO THE EPA AND CDC: ECP10 H₂O₂ Disinfectant/Cleaner has demonstrated effectiveness against viruses similar to COVID-19 / NOVEL CORONAVIRUS / 2019-nCoV infection on hard, nonporous surfaces. Therefore, ECP10 H₂O₂ Disinfectant/Cleaner can be used against COVID-19 / NOVEL CORONAVIRUS / 2019-nCoV infection when used in accordance with the directions for use against Norovirus / Feline Calicivirus on hard, nonporous surfaces. When used as directed, ECP10 H₂O₂ Disinfectant/Cleaner Kills Methycillin Resistant Staphylococcus Aureas (MRSA) and Community Acquired Methycillin Resistant Staphylococcus Aureas (CA-MRSA).

Refer to the CDC website at <https://www.cdc.gov/coronavirus/2019-nCoV/index.html> for additional information.

Item	Available Size(s)
680960	(4) 1 gal./case



NL763-Q12

Sani-Spritz RTU Cleaner/Disinfectant

Sani-Spritz RTU Cleaner Disinfectant is a one-step disinfectant cleaner that is effective against viruses similar to 2019 Novel Coronavirus (SARS-CoV-2) on hard non-porous surfaces when used in accordance with the directions. Nyco Sani-Spritz RTU Cleaner & Disinfectant's main chemical ingredient Quaternary Ammonium has been approved safe for use in all surfaces of vehicle interiors.

Note: Only 2 spray heads per case

Item	Available Size(s)
NL763-Q12	(12) 32 oz./case



TEC99419

Foaming Disinfectant Cleaner

The easy way to clean and deodorize. Formulated to act like a disinfectant. Spray, then wipe clean. Antibacterial formula great for nursery, home, hospitals and sick rooms.

Item	Available Size(s)	Pallet Count
TEC99419	12 - 19 oz. cans/case	(100 cases/pallet)

TEC285



Deodorizer



Deodorizer is an innovative breakthrough approach to malodor elimination. Deodorizer identifies malodors by utilizing molecular scientific technology. The Deodorizer works by recognizing malodors through classification of chemical and physical properties. Unlike most malodor elimination products/tools that use one chemical reaction to entrap malodors; Deodorizer is unique in its approach, using multiple chemical reactions to allow for quick elimination of malodors.

Available Size(s)

TEC285CS (12) 2 oz./case
TEC28504 (4) 1 gal/case

TEC286



Rid-It Deodorizing Kit



A new generation of chlorine dioxide odor removal. Fast one hour treatment, consistent delivery by tablet that increases the PPM (parts per million) to almost double that of the leading competitor.

Available Size(s)

TEC286CS (6) 4-pack/case

RID ODOR PRO

Odor Elimination System



Technician's Choice® Rid Odor Pro is the newest solution for ridding vehicles of odor. There are so many different reasons for those tough to eliminate odors in vehicles – pets | wet carpets | smoking | food | body odor etc.! In approximately (3) minutes – Technician's Choice Rid Odor Pro can be applied to the entire interior of a vehicle (car does not need to be running), including the A/C system & trunk – with NO clean-up. Rid Odor Pro will remove cigarette and cigar smoke odor, eliminate airborne allergens such as mildew, mold and bacteria that come from your A/C vents destroys food, pet, body, smoke and any organic contaminate odors, acts as a disinfectant and leave the A/C vents smelling clean and new. Eco-friendly odor elimination product.

TEC287



Rid Odor PRO - New Car



Features a fresh "New Car" scent. Apply with TEC289 Rid Odor PRO Application Tool (see below).

Available Size(s)

TEC287BX 12/box
TEC287CS 144/case

TEC288



Rid Odor PRO - Leather



Features a fresh "Leather" scent. Apply with TEC289 Rid Odor PRO Application Tool (see below).

Available Size(s)

TEC288BX 12/box
TEC288CS 144/case

TEC289

Rid Odor PRO - Application Tool



Application tool for Rid Odor product. Comes with an empty bottle to fill with water to prime gun and adjust spray so as to not waste product.

Available Size(s)

TEC289 Each

Refer to SDS before use

JEANNIE



Vehicle Interior Cleaning System



Technician's Choice® Jeannie Vehicle Air Quality System, TEC328 + TEC329, is an excellent odor elimination system, ideal as an additional service for service lane vehicles. Any employee can safely operate the system with minimal training. This fast and effective service only takes about 20 minutes. (Removing cabin filter before and during service is recommended).

CLEANING PRODUCTS



TEC328



Jeannie Vehicle Interior Cleaning Solution

Available Size(s)

Solution designed specifically for use with the TEC329 Jeannie Vehicle Air Quality Unit. Cleans, deodorizes & freshens vehicle interior delivered via nano-droplet technology allowing for maximum coverage and contact time for the elimination of odors caused by mold, mildew, bacteria, germs and viruses.

TEC328CS 12 bottles/case

See below for additional purchase items



TEC329

Jeannie Vehicle Air Quality Unit

Available Size(s)

Easy to operate machine specifically for use with TEC328 Jeannie Vehicle Interior Cleaning Solution for the elimination of odors caused by mold, mildew, germs, bacteria and viruses. Durable unit utilizes nano-droplet technology in which solution is turned into a fine mist that permeates the vehicles cabin. Full Jeannie Air Quality Service takes less than 20 minutes.

TEC329 Each

When you purchase a case of TEC328 Jeannie Vehicle Interior Cleaning Solution, you are entitled to receive a pack of Jeannie Mirror Hangers (TEC329HANGER 50/pk)

FREE WITH PURCHASE!



Wicked Good®
odor eliminator



TEC535



Wicked Good® Odor Eliminator Air & Surface Spray

Available Size(s)

Wicked Good® Odor Eliminator is 100% all natural, incredibly effective, very safe & easy to use. Wicked Good® will eliminate odors from the air, carpet, upholstery & many other surfaces without leaving a scent behind. The spray works by chemically bonding with the odor and completely eliminating it from the area. Works in offices, basements, bathrooms, crawl spaces, etc. Made with all natural, non-toxic & biodegradable active ingredients. This product is safe to use anywhere; in all cars, trucks, RV's & SUV's; even in schools & hospitals - the possibilities are endless! Slight citrus fragrance.

TEC53532CS (6) 32 oz./case
TEC53504 (4) 1 gal./case

POS Signage available! (see page 64)

003433 Rid Odor Pro 28"x44" Windmaster Insert

003434 Rid Odor Pro 48"x30" Banner

Always wear recommended safety equipment



Specialty Solvents & Cleaners

CLEANING PRODUCTS

TEC137

99.9% Isopropyl Alcohol Wipes

Presaturated 5" x 6" wipe. Zero residue, Water free, 99.9% pure anhydrous.

Available Size(s)

TEC137CS 500/case



TEC701

70% Isopropyl Alcohol Solution

70% alcohol solution with a variety of industrial and household uses.

Available Size(s)

TEC70102CS (12) 2 oz./case
 TEC70120CS (6) 20 oz./case
 TEC70132CS (6) 32 oz./case
 TEC70104 (4) 1 gal./case
 TEC70105 5 gal./HP



TEC243

Anti-Scaler

TEC243 Anti - Scaler is our new "clean-up" product. It is a combination of detergents and surfactants that break down scaling in extractors. Scaling is caused by hard water and calcium. This product will break down even the toughest calcium build ups in tanks, heat coils and other extractor parts. Pour TEC243 in the tank, let it set and circulate through the system, flush and dispose of. TEC243 is designed to fix the toughest problem. Don't forget to pair with TEC231 Carpet Extractor Shampoo (pg. 34) with Anti-Scaler for your maintained extractors. Biodegradable.

Available Size(s)

TEC24304 (4) 1 gal./case



TEC246

3 in 1 Surface Clarifier™

3 in 1 Surface Clarifier™ is the next evolution in total vehicle decontamination and is safe for use on all of the vehicle's exterior. TEC246 can be used as a spot treatment or for whole vehicle decontamination. 3 in 1 Surface Clarifier™ utilizes effective chemistry but is 100% Acid/VOC free. This acid alternative product is also non-corrosive, non-fuming, non D.O.T. regulated, 100% biodegradable, has hardly any odor and safely dilutes with water. Surface contaminants are quickly removed from the surface with little to no agitation required.

Available Size(s)

TEC24604 (4) 1 gal./case
 TEC24605 5 gal./HP
 TEC24655 55 gal./drum



TEC305

Clean Screen - Electronic Screen Cleaner

For Automotive, Home & Office. TEC305 is a unique, high quality, water based cleaner with an anti-static for all navigation systems, touch screens, monitors, notebooks/laptops, televisions, camcorders, PDAs, scanners, and copy machines. Works to remove dirt, dust, fingerprints, nicotine & haze deposits.

Available Size(s)

TEC30502CS (12) 2 oz./case
 TEC30516CS (6) 16 oz./case



TEC388

Fallout Wash Gel

Designed to take off all airborne contaminants and/or rail dust from the vehicle. Performs great in hard water with a gel-like cling that results in impressive contact time with surfaces.

Available Size(s)

TEC38804 (4) 1 gal./case
 TEC38805 5 gal./HP
 TEC38815 15 gal./keg
 TEC38855 55 gal./drum



Refer to SDS before use



TEC529
Bug A Boo



CONCENTRATE. Quickly removes bug spatter from bumpers, hoods, roofs, painted, plastic & chrome surfaces. Excellent hard water stability. Phosphate free. Safe for most paint and plastic. Biodegradable. Dilute up to 1:2. Berry fragrance.

Available Size(s)

- TEC52904 (4) 1 gal./case
- TEC52905 5 gal./HP
- TEC52915 15 gal./keg
- TEC52955 55 gal./drum



TEC702
Sapper Tree Sap Remover

Removes tree sap from painted surfaces, plastic, rubber, glass, molding. Penetrates & softens. Easily wipes away. Excellent hard water stability. Non-toxic. Pine fragrance.

Available Size(s)

- TEC70232 (6) 32 oz./case
- TEC70204 (4) 1 gal./case



TEC489
Powdered Laundry Soap



CONCENTRATE. Controlled suds, all-purpose cleaner designed to clean institutional & light industrial laundry applications. For use in hot or cold water. Economical. Dilute up to 1/2 cup per standard load. Lemon-lime fragrance.

Available Size(s)

- TEC48950 50 lb. drum



TEC491
Powdered Laundry Detergent



CONCENTRATE. Fully dispersible powder with a powerful blend of builder, alkalis, surfactants & brighteners. Great for towels. Dilute up to 1/2 cup per standard load. Lemon fragrance.

Available Size(s)

- TEC49135 35 lb. drum
- TEC49150 50 lb. drum
- TEC491100 100 lb. drum



TEC496
Oxy-Bright



CONCENTRATE. Non-chlorinated, oxygenated bleach developed to remove all types of stains & odors from all types of surfaces. Great laundry booster that will improve the brightness & whitening of fabrics. Dilute 4 oz. per standard load. Citrus fragrance.

Available Size(s)

- TEC496 (2) 8 lb. containers/case



TEC800
Liquid Laundry Detergent



CONCENTRATE. Pre-treat tough or set-in stains or add to wash before clothes. Fabric brightening agents. Phosphate free. Biodegradable. Economical. Dilute 1/2 - 1 cup per standard load heavily soiled clothes; 1/4 - 1/2 cup per standard load lightly soiled. Fresh fragrance.

Available Size(s)

- TEC80004 (4) 1 gal./case
- TEC80005 5 gal./HP
- TEC80055 55 gal./drum

Always wear recommended safety equipment

Tire / Wheel Cleaners

NON-ACID BASED



TEC92/315



Whitewall Tire Cleaner Concentrate

Available Size(s)

CONCENTRATE. Double strength. Removes curb burns, discoloration, grease, grime. Cleans vinyl, rubber mats & more. Biodegradable. Dilute for heavy duty 1:2; for medium duty 1:8; for light duty 1:16.

TEC92/31504 (4) 1 gal./case
TEC92/31505 5 gal./HP
TEC92/31515 15 gal./keg
TEC92/31555 55 gal./drum



TEC258



Brake-R Non-Acid Tire & Wheel Cleaner

Available Size(s)

A revolutionary formula allows this thick, gel-like cleaner to cling to the surface, aggressively removing even the toughest brake dust, dirt & grime. Perfect for the hard to clean European brand wheels with brake dust problems. Biodegradable. RTU or can be diluted up to 1:1.

TEC25832CS (6) 32 oz./case
TEC25804 (4) 1 gal./case
TEC25805 5 gal./HP
TEC25815 15 gal./keg
TEC25830 30 gal./drum
TEC25855 55 gal./drum



TEC437



Whitewall Tire Cleaner

Available Size(s)

CONCENTRATE. Water based formula removes factory coating including tire blue, curb burns, dirt & stains. Works great in the Foam-A-Nator (pg. 59). Biodegradable. Dilute up to 1:6.

TEC43704 (4) 1 gal./case
TEC43705 5 gal./HP
TEC43755 55 gal./drum



TEC516



Wheels Non-Acid Wheel Cleaner

Available Size(s)

CONCENTRATE. Foaming, non-acid wheel cleaner. Safe for clear-coated alloy, chrome, painted, plastic & stainless steel wheels. Works great in the Foam-A-Nator (pg. 59). Biodegradable. Dilute up to 1:4.

TEC51604 (4) 1 gal./case
TEC51605 5 gal./HP
TEC51615 15 gal./keg
TEC51655 55 gal./drum



TEC244



I Can't Believe it's Not Acid Wheel Cleaner™

Available Size(s)

I Can't Believe it's not Acid Wheel Cleaner™ utilizes a revolutionary new chemistry which works as fast as traditional acids but is 100% acid/VOC free, non-corrosive, non-fuming, safe on eyes and skin, non-D.O.T. regulated, and 100% biodegradable. TEC244 acid alternative instantly starts to dissolve brake dust and grime upon contact. Only light agitation is needed for a completely clean surface. The product has minimal smell and works well on all OEM wheels, including brake calipers and supporting hardware.

TEC24404 (4) 1 gal./case
TEC24405 5 gal./HP
TEC24455 55 gal./drum

Refer to SDS before use



TEC309/88

Wire Wheel Cleaner



CONCENTRATE. Industrial strength. Acid based (hydrofluoric & sulfuric blend). Removes tarnish, brake residue & rust from chrome & wire wheels. Do not let product dry on wheel. Follow all instructions & wear proper safety equipment. Biodegradable. Dilute up to 1:4 depending on the severity of rust & brake dust to be removed.

Available Size(s)

- TEC309/8804 (4) 1 gal./case
- TEC309/8805 5 gal./HP
- TEC309/8815 15 gal./keg
- TEC309/8855 55 gal./drum



TEC310

Tough Stuff Wire Wheel Cleaner



CONCENTRATE. Our most powerful acid-based (hydrofluoric) formula available. Use on wire wheels & chrome. Do not let product dry on wheel. Follow all instructions & wear proper safety equipment. Biodegradable. Dilute from 1:1 to 1:6 depending on the severity of rust & brake dust to be removed.

Available Size(s)

- TEC31004 (4) 1 gal./case
- TEC31005 5 gal./HP
- TEC31015 15 gal./keg
- TEC31055 55 gal./drum



TEC655

Express Acid Wheel Cleaner



CONCENTRATE. A powerful acid-based (hydrofluoric) formula. Professional strength wheel cleaner & brightener to be used on wire wheels, chrome & alloys. Instantly removes road film, & oxidation on metals to restore luster. Will also remove brake dust. Biodegradable. Dilute 1:4 for normal use, 1:2 for brake cleaner removal & 1:1 for severely rusted chrome wheels.

Available Size(s)

- TEC65504 (4) 1 gal./case
- TEC65505 5 gal./HP
- TEC65555 55 gal./drum



TEC729

Bulk Wire Wheel Cleaner



CONCENTRATE. Industrial strength. Acid based (hydrofluoric & sulfuric blend). Removes tarnish, brake residue & rust from chrome & wire wheels. Do not use on plastic or polished aluminum wheels. Biodegradable.

Available Size(s)

- TEC72955 55 gal./drum



TEC888

Purple Magic Wheel Brightener



CONCENTRATE. A powerful blend of wetting agents & ammonium bifluoride, combined to improve penetrating power & provide excellent rinsing properties. Instantly removes road film, brake dust, rust & restores luster to clear coated wheels. Do not use on plastic or polished aluminum wheels. Biodegradable. Cherry fragrance.

Available Size(s)

- TEC88804 (4) 1 gal./case
- TEC88805 5 gal./HP
- TEC88815 15 gal./keg
- TEC88830 30 gal./drum
- TEC88855 55 gal./drum

See page 100-101 for Safety Supplies

DEGREASERS

Solvent Based & Water Based

DEGREASERS



TEC300



Odorless Mineral Spirits

Available Size(s)

Cleans rust protection overspray, tar & bugs. Acts as a spot remover. Can be used as a cut back material in solvent systems. Naptha solvent overspray remover. Biodegradable.

TEC30004 (4) 1 gal./case
TEC30005 5 gal./HP
TEC30055 55 gal./drum



TEC375/86



Super Solvent

Available Size(s)

A blend of cleaning solvents developed especially to meet the requirements of the professional New Car Prep Department. Removes grease, gum, spots & stains on vinyl & upholstery – adhesives, sealers & rubber cements on vinyl, waxes, tar, silicones, undercoating overspray & gummy substances on hard surfaces. Safe on all automotive finishes. Will not leave rings or stains on cloth interiors. Biodegradable.

TEC375/8604 (4) 1 gal./case
TEC375/8605 5 gal./pail
TEC375/8655 55 gal./drum

SOLVENT BASED



TEC386



Solution Now

Available Size(s)

CONCENTRATE. A high quality all purpose degreaser which quickly & effectively cuts grease & grime from auto & truck engines. Emulsion cleaning system is formulated with fast acting, penetrating agents & surface active detergents. Use in hot or cold water. Dilute up to 1:2.

TEC38604 (4) 1 gal./case
TEC38605 5 gal./HP
TEC38655 55 gal./drum



TEC525



Citrus Solvent

Available Size(s)

A powerful D-limonene and odorless mineral spirit based cleaner. Melts or removes tar, dissolves grease, grime & oil deposits from engines. Emulsifies grease & oil. Biodegradable. Non-abrasive. Citrus fragrance.

TEC52504 (4) 1 gal./case
TEC52505 5 gal./HP
TEC52555 55 gal./drum

Refer to SDS before use



TEC239

Blackhawk Industrial HD Cleaner & Degreaser

CONCENTRATE. This concentrated non-silicate formula can be used on glass, paint, rubber, anodized aluminum and more. Penetrates deep to remove oil, dirt, grease and soot. Can be used as a fleet wash, steam cleaner or degreaser. Industries served: automotive, fleet, transportation, construction, printers & industrial food plants. Biodegradable. Dilute up to 1:120. Our 32 oz. spray bottle version is a ready-to-use formula.

Available Size(s)

- TEC23904 (4) 1 gal./case
- TEC23905 5 gal./HP
- TEC23915 15 gal./keg
- TEC23930 30 gal./drum
- TEC23955 55 gal./drum



TEC259

Brake-X Water-Based Brake & Parts Cleaner/Degreaser

A revolutionary water-based cleaner/degreaser with corrosion buffers that works great on brakes & parts. Biodegradable. This concentrated formula can be cut up to 1:4 to accommodate any cleaning or degreasing needs.

Available Size(s)

- TEC25904 (4) 1 gal./case
- TEC25905 5 gal./HP
- TEC25915 15 gal./keg
- TEC25930 30 gal./drum
- TEC25955 55 gal./drum



TEC370/25

Engine Shampoo

CONCENTRATE. Cleans motors, engine compartments, door jambs & concrete floors. Water-based. Great with a foamer. Excellent hard water stability. Biodegradable. Dilute up to 1:2.

Available Size(s)

- TEC370/2504 (4) 1 gal./case
- TEC370/2505 5 gal./HP
- TEC370/2515 15 gal./keg
- TEC370/2555 55 gal./drum



TEC387

Orange Crush All Purpose Cleaner/Degreaser

CONCENTRATE. All purpose cleaner/degreaser that combines water miscible solvents, alkaline hydroxides & non-ionic detergents to remove grease & grime from any hard surface areas. No abrasives, phosphate free. Excellent hard water stability. Biodegradable. Dilute up to 1:1 to 1:50. Citrus fragrance.

Available Size(s)

- TEC38704 (4) 1 gal./case
- TEC38705 5 gal./HP
- TEC38715 15 gal./keg
- TEC38730 30 gal./drum
- TEC38755 55 gal./drum



TEC482

Purple Thunder

CONCENTRATE. Formulated for floors, engines, tires, wheels, spot removing & white wall tires. Economical to use. Phosphate free. Excellent hard water stability. Biodegradable. Dilution: 1:4 heavy duty cleaning; 1:8 medium duty cleaning; 1:16 light duty cleaning.

Available Size(s)

- TEC48204 (4) 1 gal./case
- TEC48205 5 gal./HP
- TEC48255 55 gal./drum

DEGREASERS

WATER BASED

Always wear recommended safety equipment



DRESSINGS

Solvent Based Non-Silicone & Silicone

DRESSINGS

NON-SILICONE
FLAMMABLE

SILICONE
COMBUSTIBLE



TEC414 Reflections



A blend of high molecular weight surfactant polymers designed to give excellent gloss & detergent resistance on rubber & vinyl surfaces. Fast drying properties and also may be used as a rubber-vinyl dressing where silicone tire dressings can not be tolerated. Flammable. Vanilla fragrance.

Available Size(s)

TEC41404 (4) 1 gal./case
TEC41405 5 gal./HP
TEC41453 53 gal./drum



TEC452 Progressive™ Solvent-Based Dressing



Progressive™ dressings replace traditional silicone oils with a synthetic, polymeric hybrid raw material. The new raw material was specifically tailored for automotive rubber application. The product has superior high temperature stability, excellent lubricity, and can be applied across a wide range of temperatures.

Progressive™ dressings are a cost-effective solution for the volatile silicone market, while maintaining original (silicone) type product performance characteristics. The high viscosity synthetic complex is bio-based, which makes it both environmentally friendly and biodegradable. Repeated use will help to nourish porous rubber and extend the look life of the surface.

Available Size(s)

TEC45205 5 gal./HP



TEC453V Progressive™ Solvent-Based Dressing - Low VOC



Progressive™ dressings replace traditional silicone oils with a synthetic, polymeric hybrid raw material. The new raw material was specifically tailored for automotive rubber application. The product has superior high temperature stability, excellent lubricity, and can be applied across a wide range of temperatures.

Progressive™ dressings are a cost-effective solution for the volatile silicone market, while maintaining original (silicone) type product performance characteristics. The high viscosity synthetic complex is bio-based, which makes it both environmentally friendly and biodegradable. Repeated use will help to nourish porous rubber and extend the look life of the surface.

Available Size(s)

TEC453V05 5 gal./HP



TEC400/34 New Gloss Dressing

SOLVENT/SILICONE SYSTEM. Surface dressing for vinyl, rubber, plastic, rubber bumpers & tires. High gloss formula. Combustible. Fruity fragrance.

Available Size(s)

TEC400/3404 (4) 1 gal./case
TEC400/3405 5 gal./HP

Refer to SDS before use

DRESSINGS

COMBUSTIBLE

SILICONE

FLAMMABLE



TEC405/37A

New Tire Dressing

SOLVENT/SILICONE SYSTEM. Provides shine & gloss with durability. Combustible. Vanilla fragrance.

Available Size(s)

- TEC405/37A04 (4) 1 gal./case
- TEC405/37A05 5 gal./HP



TEC415

Cherry Shine Tire Dressing VOC/OTC

SOLVENT/SILICONE SYSTEM. A VOC / OTC compliant system combined with a high viscosity silicone especially developed to maximize gloss and protect old and new tires. May be wiped, brushed or sprayed on. Formulated for sale and use in California and OTC states.

Available Size(s)

- TEC41504 (4) 1 gal./case
- TEC41505 5 gal./HP
- TEC41515 15 gal./keg
- TEC41555 55 gal./drum



TEC416

Shine All Tire Dressing VOC/OTC

SOLVENT/SILICONE SYSTEM. High and low viscosity system to give one coat leveling for long term gloss. Combustible. Vanilla fragrance. Formulated for sale and use in California and OTC states.

Available Size(s)

- TEC41604 (4) 1 gal./case
- TEC41605 5 gal./HP
- TEC41615 15 gal./keg
- TEC41655 55 gal./drum



TEC401

Snappy Purple Tire Dressing

SOLVENT/SILICONE SYSTEM. A blend of high & low viscosity silicones designed to give excellent gloss & leveling properties to tires. Use on all exterior surfaces. Fast drying. Flammable. Grape fragrance.

Available Size(s)

- TEC40104 (4) 1 gal./case
- TEC40105 5 gal./HP
- TEC40115 15 gal./keg
- TEC40153 53 gal./drum



TEC402

Ice Purple Tire Dressing

SOLVENT/SILICONE SYSTEM. Features reduced sling. Non-greasy, very durable. High shine with very little set-up time. Fast dry with great results. Flammable. Grape fragrance.

Available Size(s)

- TEC40204 (4) 1 gal./case
- TEC40205 5 gal./HP
- TEC40215 15 gal./keg
- TEC40253 53 gal./drum



TEC404/36

Snappy Shine Tire Dressing

SOLVENT/SILICONE SYSTEM. A blend of high & low viscosity silicones designed to give excellent gloss & leveling properties to tires. Use on all exterior surfaces. Fast drying. Flammable. Vanilla fragrance.

Available Size(s)

- TEC404/3604 (4) 1 gal./case
- TEC404/3605 5 gal./HP
- TEC404/3615 15 gal./keg
- TEC404/3653 53 gal./drum

Always wear recommended safety equipment



Solvent Based Silicone

DRESSINGS

FLAMMABLE

SILICONE



TEC404/36V



Snappy Shine Tire Dressing VOC | OTC

SOLVENT/SILICONE SYSTEM. A blend of high & low viscosity silicones designed to give excellent gloss & leveling properties to tires. Use on all exterior surfaces. Fast drying. Flammable. Vanilla fragrance.

Available Size(s)

TEC404/36V04	(4) 1 gal./case
TEC404/36V05	5 gal./HP
TEC404/36V15	15 gal./keg
TEC404/36V53	53 gal./drum



TEC408

Ice Blue Tire Dressing

SOLVENT/SILICONE SYSTEM. Features reduced sling. Non-greasy, very durable. High shine with very little set-up time. Fast dry with great results. Flammable. Vanilla fragrance.

Available Size(s)

TEC40804	(4) 1 gal./case
TEC40805	5 gal./HP
TEC40815	15 gal./keg
TEC40853	53 gal./drum



TEC408V



Ice Blue Tire Dressing VOC | OTC

SOLVENT/SILICONE SYSTEM. Features reduced sling. Non-greasy, very durable. High shine with very little set-up time. Fast dry with great results. Flammable. Vanilla fragrance.

Available Size(s)

TEC408V04	(4) 1 gal./case
TEC408V05	5 gal./HP
TEC408V53	53 gal./drum



TEC450/38

Bumper Restorer

SILICONE SYSTEM. Thick, rich formula that revitalizes rubber & plastic trim as well as painted bumpers. Strawberry fragrance.

Available Size(s)

TEC450/3832CS	(6) 32 oz./case
---------------	-----------------





Water Based Non-Silicone

DRESSINGS

NON-SILICONE



TEC418
Perfect Tire Dressing



Formulated to be a staple in every body shop. For use on tires & all of your rubber & vinyl areas. The silicone free blend is designed to outperform most glycerin & water based silicone emulsion type dressings. Sprayable for easy application & promises the finest gloss & durability. Bubble gum fragrance.

Available Size(s)

- TEC41816CS (6) 16 oz./case
- TEC41804 (4) 1 gal./case
- TEC41805 5 gal./HP
- TEC41815 15 gal./keg
- TEC41830 30 gal./drum
- TEC41855 55 gal./drum



TEC432
Clear Dressing



CONCENTRATE. Maximum gloss for a low price. For use on engine compartments, tires, weather stripping, rubber floor mats & more. Dilute 1:1 with water or RTU for an extreme shine.

Available Size(s)

- TEC43204 (4) 1 gal./case
- TEC43205 5 gal./HP
- TEC43215 15 gal./keg
- TEC43255 55 gal./drum



TEC436
Red Silicone-Free Dressing



CONCENTRATE. A solvent and silicone-free dressing for use on all exterior vehicle surfaces that are exposed to the sunlight. Excellent preservative dressing for tires, engine compartments, weather stripping, rubber floor mats, bumpers & more.

Available Size(s)

- TEC43604 (4) 1 gal./case
- TEC43605 5 gal./HP
- TEC43655 55 gal./drum



TEC451
Progressive™ Water-Based Dressing



Progressive™ dressings replace traditional silicone oils with a synthetic, polymeric hybrid raw material. The new raw material was specifically tailored for automotive rubber application. The product has superior high temperature stability, excellent lubricity, and can be applied across a wide range of temperatures.

Available Size(s)

- TEC45105 5 gal./HP

Progressive™ dressings are a cost-effective solution for the volatile silicone market, while maintaining original (silicone) type product performance characteristics. The high viscosity synthetic complex is bio-based, which makes it both environmentally friendly and biodegradable. Repeated use will help to nourish porous rubber and extend the look life of the surface.



Water Based Silicone

DRESSINGS



TEC325

Blue Sapphire Dressing

WATER BASED/SILICONE SYSTEM. A blend of high & low viscosity silicones designed to give excellent gloss & leveling properties to tires. Use on all exterior and most interior surfaces. Fast drying. Grape fragrance.

Available Size(s)

TEC32522CS	(12) 22 oz./case
TEC32504	(4) 1 gal./case
TEC32505	5 gal./HP
TEC32515	15 gal./keg
TEC32530	30 gal./drum
TEC32555	55 gal./drum



TEC410/89

Rubber & Vinyl Dressing Original

Preserves, renews rubber, vinyl & leather. Use on tires, weather stripping, rubber floor mats, vinyl, leather interiors, bumpers, molding & engine compartments. Long lasting. Biodegradable. 24 hour cure = 30 day shine. Floral fragrance.

Available Size(s)

TEC410/8904	(4) 1 gal./case
TEC410/8905	5 gal./HP
TEC410/8955	55 gal./drum



TEC417

Blue Velvet Tire Dressing

A fourth generation development stemming from Green Sheen & Strawberry Sheen that uses a mixture of water & silicone to create a durable dressing to outshine the rest. Bubble gum fragrance.

Available Size(s)

TEC41716CS	(6) 16 oz./case
TEC41704	(4) 1 gal./case
TEC41705	5 gal./HP
TEC41715	15 gal./keg
TEC41730	30 gal./drum
TEC41755	55 gal./drum

Don't forget to order TEC417GUN Blue Velvet Precision Applicator! (page 56)



TEC427/76

Super Dress Dressing

Preserves interior leather, vinyl & rubber. Spray on engine compartments. Restores non-porous surfaces. Biodegradable. Pleasant fragrance.

Available Size(s)

TEC427/7604	(4) 1 gal./case
TEC427/7605	5 gal./HP
TEC427/7655	55 gal./drum



TEC434

Shine & Shield Conditioner Dressing

SUPER CONCENTRATE. Blend of high & low molecular weight silicone emulsions plus gloss promoters designed to give unsurpassed gloss. Excellent renewer & preservative for old & new tires, vinyl moldings, floor mats & bumpers. Solvent free. Super gloss. Excellent lubricating properties and emulsion stability. Dilute up to 1:4 for best results. Cherry fragrance.

Available Size(s)

TEC43405	5 gal./HP
TEC43455	55 gal./drum

Refer to SDS before use

DRESSINGS

SILICONE



TEC435



Rubber & Vinyl Dressing Concentrate

CONCENTRATE. Cut 1:1 with water - will remain detergent resistant for 30 days or more. Renewer, preservative for rubber, vinyl and leather. Renews tires, rubber floor mats, bumpers & more. Biodegradable. Floral fragrance.

Available Size(s)

- TEC43504 (4) 1 gal./case
- TEC43505 5 gal./HP
- TEC43555 55 gal./drum



TEC483



Lemon Supreme Dressing

CONCENTRATE. Silicone based, rubber & vinyl dressing. Excellent gloss. Non-flammable. Renew tires, rubber floor mats, interiors, bumpers, weather stripping & engines. Biodegradable. Lemon fragrance.

Available Size(s)

- TEC48304 (4) 1 gal./case
- TEC48305 5 gal./HP
- TEC48315 15 gal./keg
- TEC48355 55 gal./drum



TEC486



Fantastic 4our

Our best water-based/silicone system is a blend of fine particle size, high & low molecular weight & silicone emulsions designed to give unsurpassed gloss for external & internal use. Biodegradable. Ready to use. Bubble gum fragrance.

Available Size(s)

- TEC48616CS (6) 16 oz./case
- TEC48604 (4) 1 gal./case
- TEC48605 5 gal./HP
- TEC48615 15 gal./keg
- TEC48655 55 gal./drum



TEC498



Strawberry Sheen Dressing

Third generation development in tire dressing which utilizes water in place of slow & fast evaporating solvents & utilizes high & low molecular weight silicones. Greater durability than the water based systems & equal in durability to most solvent based tire dressings. Apply to surface, wet or dry. Excellent durability, minimum sling. RTU. Strawberry fragrance.

Available Size(s)

- TEC49816CS (6) 16 oz./case
- TEC49804 (4) 1 gal./case
- TEC49805 5 gal./HP
- TEC49815 15 gal./keg
- TEC49855 55 gal./drum



TEC499



Green Sheen Dressing

Third generation development in tire dressing which utilizes water in place of slow & fast evaporating solvents & utilizes high & low molecular weight silicones. Greater durability than the water based systems & equal in durability to most solvent based tire dressings. Apply to surface, wet or dry. Excellent durability, minimum sling. RTU. Watermelon fragrance.

Available Size(s)

- TEC49916CS (6) 16 oz./case
- TEC49904 (4) 1 gal./case
- TEC49905 5 gal./HP
- TEC49915 15 gal./keg
- TEC49955 55 gal./drum



TEC654



Express Pink Passion Dressing

CONCENTRATE. A blend of high & low molecular weight silicone emulsions designed to provide a glossy finish with maximum performance. Will also rejuvenate leather & vinyl with an invisible protective coating to keep it soft & flexible. Watermelon fragrance.

Available Size(s)

- TEC65405 5 gal./HP
- TEC65455 55 gal./drum

Always wear recommended safety equipment



Buffers | Polishers

EQUIPMENT



T-21

Tornador® T-21 Dual Action Polisher

Available Size(s)

The Tornador® T-21 Dual Action Polisher is the perfect tool for all professional detailers that desire the best results. The T-21 levels, polishes, and finishes automotive paint resulting in that deep gloss and shine without swirling and scratching. Whatever the job is, the T-21 DA Polisher is your answer!. Lightweight, easy-to-use, ideal for the novice or the experienced.

T-21 Each

Orbit: 21 Millimeter Random Orbit. **Speed Dial:** 6 Speed. **No Load Speed:** 1700-4200 RPM. **Input Power:** 500-1200 Watts. **Cord:** 15 Foot with Cord Keeper. **Weight:** 7.4 lbs. Comes with a 6 inch hook & loop backing plate*, a wrench for backing plate, an Allen wrench for handle**, an extra set of carbon brushes and a T-21 User's Manual. (* Backing Plate - 610462, ** D Handle for T-21 - 610466)

Warranty: 1 Year Manufacturer Warranty.



T-21C

Tornador® T-21C Cordless Dual Action Polisher

Available Size(s)

Tornador® T-21C Cordless RO/DA Polisher the perfect tool for all professional detailers and home enthusiasts that desire the best results without the cords getting in the way! Lightweight, easy-to-use, ideal for the novice or the experienced. The T-21C is the most convenient way to level, polish, and finish automotive paint, resulting in that deep gloss and shine without swirling and scratching. Use the T-21C to spot correct, swirl remove, and/or apply protection. Whatever the job is, the T-21C DA Polisher is your answer!

T-21C Each

Orbit: 21 Millimeter Random Orbit. **Motor:** Brushless. **Speed Dial:** 3 Speed. **No Load Speed:** 2700-3600 RPM. **Voltage:** 21 Volts. Amps: 5.0 Ah. **Weight:** 5.5 lbs (2.5 Kg). Comes with a 6 inch hook & loop backing plate*, a wrench for backing plate, 1-21V Battery & Charger and a T-21C User's Manual. (* Backing Plate - 610462)

Warranty: 1 Year Manufacturer Warranty. 90 days for battery.



T-21BATTERY

Tornador® T-21C 21V Battery

Available Size(s)

Replacement 21v/5.0 Ah Li-Ion Rechargeable Battery for the Tornador® T-21C Cordless DA Polisher.

Rated voltage: 21V. **Battery capacity:** 5000mAh.

Warranty: 90 days for battery.

T-21BATTERY Each



492461

Dewalt® Variable Speed Polisher

Available Size(s)

DW849 Powerful 8.0 amp, all ball-bearing construction for long life. Electronic module maintains specified speed even under load. Conveniently located variable speed dial lets user set maximum speed from 1,000 to 3,000 for different materials and applications. Variable speed trigger allows user to instantly control speed from 0 to dialed setting. Heat-treated, precision-cut gears for smooth operation. External brush caps for easy servicing. Spindle lock button allows for single-wrench bit changes. 8.25 lbs.

492461 Each

Warranty*: 3 Year Limited Warranty. 1 Year Service Contract.

90 Day Satisfaction Guarantee. *Warranty Provided by Manufacturer

610461**Flex Orbital Polisher**

The orbital rotation simulates the circular movement of the human hand while polishing & promises a smooth, precise finish with very little heat generated on the surface. This will ensure the safety of your customers most sensitive finishes. This unit features an automatic shut-off if it becomes too hot, to protect the motor. 10 amps. 5.7 lbs. Comes with a 5.5 inch hook & loop backing plate. (Pad shown not included).
Warranty: 1 Year Manufacturer Warranty.

Available Size(s)

610461 Each

610561**Flex Variable Speed Polisher**

This polisher boasts a low weight for ease of use, in addition to running extremely quietly. Constant / Continuous speed control offers 600-2100 rpms. Developed by professionals for professionals. 10 amps. 5.6 lbs. Compatible with 5/8-11 backing plates. (Backing plate and pad shown not included).
Warranty: 1 Year Manufacturer Warranty.

Available Size(s)

610561 Each

TEC1610**E-15 RO / DA Polisher**

This buffer is packed with value for a fraction of the price. This is our import model priced 35% less than its European counterpart. Lightweight, easy-to-use, ideal for the novice or the experienced.
Speed Dial: 6 Speed. **No Load Speed:** 1700-4200 RPM. **Input Power:** 500-1200 Watts. **Orbit:** 15 Millimeters. **Cord:** 15 Foot with Cord Keeper. **Weight:** 7.4 lbs. Comes with a 5 inch hook & loop backing plate, a wrench for backing plate, an Allen wrench for handle, a user's manual and an extra set of carbon brushes.
Warranty: 1 Year Manufacturer Warranty.

Available Size(s)

TEC1610 Each

TEC1611**E-12 RO/DA Polisher**

TEC1611 E-12 DA Polisher is the next tool to put in your ever expanding arsenal! Packing similar specs as our larger polishers but with an even smaller throw to conquer spot correction where the larger machines will not fit. Ideal for tight curves around fog lights, headlights, side mirrors, spoilers, and more. Lightweight, easy-to-use, ideal for a novice or the experienced. **Speed Dial:** 6 Speed. German Bearings. **No Load Speed:** 1800-5200 RPM. **Motor:** 850 Watts. **Orbit:** 12 Millimeters. **Cord:** 12 Foot with Cord Keeper. **Weight:** 5 lbs. Comes with a 3 inch hook & loop backing plate, a wrench for backing plate, an Allen wrench for handle, a user's manual and an extra set of carbon brushes.
Warranty: 1 Year Manufacturer Warranty.

Available Size(s)

TEC1611 Each

TEC1602**Mini Air Tool**

Built to industrial standards for the professional user providing more power, less noise and longer life. This gun is ideal for hard to reach, delicate areas, such as painted dash boards, interior trim parts as well as small aluminum parts that require a small polisher with good control.

Available Size(s)

TEC1602EA Each

- 2,500 RPM free speed
- Compact and lightweight (2 lbs.) for easy access in hard to reach areas
- Adjustable power regulator
- Two finger throttle for easier control & less fatigue
- Rubber molded grip for comfort
- Handle exhaust with silencing reduces noise & directs air away from work area
- Kit features tool, 3" backplate, wrench & instructions

Warranty: 2 Year Manufacturer Warranty.

Extractors

EQUIPMENT



ECP3

3-Gallon Automotive Extractor with Heat

Available Size(s)

Tanks: Roto-Molded Polyethylene, 3-Gallon Solution and 3-Gallon Recovery Tank Capacity
Solution Pump: 55 psi
Vacuum Motor: 2-Stage Ametek, 804 Watt/100 CFM
Voltage: 115 Volts **Water Lift:** 76"
In-Line Heater: 600 Watt
Hoses and Tools: Includes (1) 800603 15 Ft. Vacuum Hose, (1) 800605 15 Ft. Solution Hose and (1) 800600 4-Inch Stainless Steel Upholstery Tool
Power Cord: (1) 20-Foot, 16/3-Gauge Safety Power Cord
Dimensions: 25" L x 11" W x 29" H **Shipping Weight:** 42 lbs.
Warranty: Lifetime on Roto-Molded Body, 2-Years on Motor, Pump and all Electrical
 *Warranty Provided by Manufacturer

ECP3 Each



ECP6

6-Gallon Automotive Extractor with Heat

Available Size(s)

Tanks: Roto-Molded Polyethylene, 6-Gallon Solution and 6-Gallon Recovery Tank Capacity
Solution Pump: 100 psi
Vacuum Motor: Single 3-Stage, 99 CFM
Voltage: 115 Volts **Water Lift:** 117"
Amps: 15 Amp Breaker
In-Line Heater: 1200 Watt
Hoses and Tools: Includes (1) 800603 15 Ft. Vacuum Hose, (1) 800605 15 Ft. Solution Hose and (1) 800600 4-Inch Stainless Steel Upholstery Tool
Power Cord: (1) 25-Foot, 16/3-Gauge Safety Power Cord
Dimensions: 26" L x 17" W x 35" H **Shipping Weight:** 82 lbs.
Warranty: Lifetime on Roto-Molded Body, 2-Years on Motor and Pump, 1-Year on all Electrical *
 Warranty Provided by Manufacturer

ECP6 Each



ECP12

12-Gallon Automotive Extractor with Heat

Available Size(s)

Tanks: Roto-Molded Polyethylene, 12-Gallon Solution & 12-Gallon Recovery Tank Capacity
Solution Pump: 100 psi
Vacuum Motor: Single 3-Stage, 99 CFM
Voltage: 115 Volts **Water Lift:** 117"
Amps: 15 Amp Breaker
In-Line Heater: 1200 Watt
Hoses and Tools: Includes (1) 800604 25 Ft. Vac, (1) 800606 25 Ft. Solution Hose and (1) 800600 4-Inch Stainless Steel Upholstery Tool
Power Cord: (1) 25-Foot, 16/3-Gauge Safety Power Cord
Dimensions: 27" L x 20" W x 38" H **Shipping Weight:** 110 lbs.
Warranty*: Lifetime on Roto-Molded Body, 2-Years on Motor and Pump, 1-Year on all Electrical
 *Warranty Provided by Manufacturer

ECP12 Each



ECP12XLDUAL

12-Gallon XL Dual Extractor with Heat

Available Size(s)

Tanks: Roto-Molded Polyethylene, 12-Gallon Solution & 12-Gallon Recovery Tank Capacity
Solution Pump: 100 psi
Vacuum Motor: Dual 3-Stage, 99 CFM
Voltage: 115 Volts **Water Lift:** 215"
Amps: (2) 15 Amp Breakers
In-Line Heater: 1200 Watt
Hoses and Tools: Includes (1) 800604 25 Ft. Vac, (1) 800606 25 Ft. Solution Hose and (1) 800600 4-Inch Stainless Steel Upholstery Tool
Power Cord: (1) 25-Foot, 16/3-Gauge Safety Power Cord
Dimensions: 27" L x 20" W x 38" H **Shipping Weight:** 112 lbs.
Warranty: Lifetime on Roto-Molded Body, 2-Years on Motor & Pump, 1-Year on all Electrical
 *Warranty Provided by Manufacturer

ECP12XLDUAL Each

Refer to SDS before use



800600
4" Stainless Steel Hand Tool

Required for machines with heat.



800601
Crevice Tool



800602
Detail Kit 4" Stainless Steel Hand Tool with 15ft Vacuum & Solution Hoses



800603
15' Vacuum Hose Assembly



800604
25' Vacuum Hose



800605
15' Solution Hose Assembly



800606
25' Solution Hose



800607
Stainless Steel 12" Dual Jet S-Bend Wand



800608
Jet for 4" Stainless Steel Hand Tool



800609
Valve for 4" Stainless Steel Hand Tool



800610
Splash Proof Switch for Vacuum Pump-No Heat



800611
Splash Proof Lighted Heater Switch



800612
6" Hatch Cover with T-Handle



800613
Gasket for Hatch Cover



800614
Dump Valve



800615
3-Stage Extractor Motor



800616
100 psi Pump



800617
Intake/Exhaust Grate



800618
1/4" Strainer



800619
25' Extension Cord



800620
1/4" Female Quick Disconnect



800621
1/4" Male Quick Disconnect



800622
3-Stage Motor Gasket



800623
#1 Jet for Extractor Wand



800624
Tip for #1 Jet for Extractor Wand



800625
Shut-Off Assembly



800626
Valve for Extractor Wand



800627
Valve Repair Kit



800628
Replacement Hose for Stainless Steel Hand Tool (800600)

Always wear recommended safety equipment

Miscellaneous

EQUIPMENT



TEC417GUN

Blue Velvet Precision Applicator

Available Size(s)

Delivers the product as evenly a solvent based dressing with no waste, no sling & a high gloss. Featuring an adjustable spray tip for any size side wall. *For replacement cup, reference 180871, for Wall Mount Spray Gun Holder, reference 180971.

Each

Warranty: 30 days on gun.



180871

TEC417GUN Replacement Cup

Available Size(s)

Replacement cup for our TEC417GUN Blue Velvet Precision Applicator.

Each



180971

TEC417GUN Wall Mount Spray Gun Holder

Available Size(s)

Keep your gun off of the floor and prevent damage. Provides a convenient area to hang gun between uses.

Each



TEC1263

Standard Air Hose

Available Size(s)

Features 3/8" I.D., 50' Length and 1/4" MNPT fittings. Workforce® PVC air hose is made from virgin resin PVC giving it excellent flexibility. Low temperature, UV, oil and abrasion resistant. The inner tube is reinforced with extra strong polyester braiding which is 20% lighter per foot. This air hose resists cracking and fading. Temp. Range: 15° to 150°F. Includes bend restrictor that reduces wear and tear. Corrosion-resistant solid brass NPT fittings.

Each



TEC1264

Deluxe Air Hose

Available Size(s)

Features 3/8" I.D., 50' Length and 1/4" MNPT fittings. SmartFlex® Hybrid Polymer Blend air hoses offer premium performance at a mid-level price point. They have an abrasion-resistant outer cover for durability. Offers cold weather flexibility and is kink-resistant under pressure. Working pressure: 300 psi.

Each



TEC1560

Jumper Pack Rescue 900

Available Size(s)

A handy tool to have in EVERY department of the dealership or car wash to jump start vehicles with dead batteries! Features: *Premium 18 Amp Hour Battery *LED Battery Status *Jump starts 12 Volt Vehicles -Mechanics Clamps *Light Weight – Easy to Use! *Long, 27" Cables (100% Copper) *DC Power Source *400 Crank Amps

Each

Warranty*: (1) Year Pro-Rated Manufacturer Warranty on battery

**Special Note: Requires a 24-48 hour INITIAL CHARGE before first use.

Refer to SDS before use



TEC3500
Pressure Washer

Drum mount 1000 psi pressure washer uses a 120 volt, single phase outlet & features a powerful 15 amp, 1.5 HP Baldor electric motor. Built with a durable steel frame, pump pushes 2 gallons per minute. Comes with a 25' hose and rigid wand. Other accessories will be available.

Warranty*: 1 Year Manufacturer's Warranty on the unit, 7 Years on the pump.
*Warranty Provided by Manufacturer

Available Size(s)

Each



TECSHOPVAC
Shop Vac

The Shop-Vac® Professional® 12 Gallon 6.5 Peak HP Wet / Dry Vacuum works great to clean wet or dry messes in your garage, workshop or basement. For those hard to reach places, simply attach the hose to the rear blower port to blow the dirt out of the way. The included Ultra-Web® cartridge filter provides the proper filtration for dry pick up and small amounts of wet pick up, while the high efficiency disposable filter bag traps fine dust and makes it easy to dispose of dry debris. The large tool storage basket and cord storage keeps the tools organized and cord untangled. Assembled in the U.S.A. of U.S. and global components.

Warranty*: The vac is backed by the Shop-Vac® one year commercial use warranty.
*Warranty Provided by Manufacturer

Available Size(s)

Each



559471
Sure-Fil Fill System

This automated filling system works exclusively with our 32oz Black Sure Shot and Sure Shot Atomizer Sprayers – *Be sure to order the 559468 Adaptor for the TEC1066 Black Sure Shot (page 105) or the 559473 Conversion Kit for the 559472 Sure Shot Atomizer (page 105).* The lever controls fills & pressurizes in seconds without removing the filler cap & the top fill port eliminates leaking seals. This unit comes with special chemical resistant seals to handle almost any product. Great for cleaners, degreasers, penetrating oils, brake cleaners & solvents. Comes complete with 55 gallon siphon tube assembly.

Warranty*: 1 year warranty under normal use, wear and conditions.
*Warranty Provided by Manufacturer

Available Size(s)

Each



559468
Filler Cap Adaptor for Black Sure Shot

For use with the TEC1066 Black Sure Shot (page 105) and 559471 Sure-Fil Fill System.

Available Size(s)

Each



559473
Conversion Kit for Sure Shot Atomizer

For use with the 559472 Sure Shot Atomizer (page 105) and 559471 Sure-Fil Fill System.

Available Size(s)

Each



559476
Sure-Fil Table*

(Table only**) 36" High, 18" deep, 24" wide. Made of heavy duty, cold rolled steel & finished with a durable, powder coat painting process. Designed to be used with and optimize use of the Sure-Fil Fill System (559471). Lower shelf provides convenient storage of Sure Shot Sprayers.

Special order item. Please allow additional time for shipping
****Product + sprayers are for display purposes only (sold separately)****

Available Size(s)

Each



Always wear recommended safety equipment



Tornador® | Foam-A-Nator

**THE MUST-HAVE
DETAILING TOOLS!**



... the fastest and easiest way to clean all automotive surfaces.

**OFTEN IMITATED...
NEVER DUPLICATED!**

TORNADOR MAX®

Z-030

TornadorMAX® Cleaning Tool ●

Available Size(s)

Tornador® has completely changed the professional detailing industry with the new the TornadorMAX®! You will see all the benefits of the Z-020 Tornador® Black with newly engineered and upgraded features. The rotate set is now equipped with a patented spring technology, which increases the torque and intensifies the cleaning power. Thanks to the spring technology the cleaning time is reduced and efficiency is greatly increased. The newly designed ergonomic handle and trigger of the TornadorMAX® provides users more control and comfort. This progressive design allows for individual customization through easily replaceable color handles and trigger grips. The TornadorMAX® also has a built-in air regulator allowing for precise control of the air pressure along with adding a swivel air inlet for flexibility. An Anti-Slip mat on the jar will allow the TornadorMAX® to stand flat even when connected to an air hose which results in minimized spills and falls. Finally, the TornadorMAX® comes with a LED tactical light to illuminate dark areas without having to incorporate bulky lights. The TornadorMAX® is the newest in the family of must have detailing tools!

Z-030 Each

LIMITED WARRANTY*

TEC1221

Tornador® Cleaning Tool ●

Available Size(s)

Tornador® Car Cleaning Tools are the fastest and easiest way to clean all automotive surfaces. TEC1221 uses a concentrated blast of solution to remove dirt from crevices. Effortlessly cleans the interior & exterior of your vehicle. The Tornador® works with your air compressor to create a tornado-like cyclone of cleaning power that blasts solution into crevices and areas you cannot reach by hand. Clean carpet, plastics, & upholstery inside the car. Clean wheels, convertible tops & body seams on the exterior. The cone-shaped nozzle and oscillating tip create a unique tornado-like cleaning action that deep cleans hard and soft surfaces like nothing you've never seen before. Releases a fine mist of cleaning solution that does not over saturate surfaces. Using a highly diluted neutral pH cleaner or water, dirt and grime are immediately released.

TEC1221 Each

Must be used with an air compressor capable of producing a constant air pressure of at least 60 psi. Do not to exceed 110 psi in order to protect your Tornador from unnecessary wear.

LIMITED WARRANTY*

TEC1233

Tornador® Black - Cleaning Tool ●

Available Size(s)

TEC1233 has newly developed rotational technology inside the funnel to provide faster, more powerful cleaning. Professional detailers will love the speed and effectiveness of the TEC1233 Tornador® Black. The new design of the tool reduces wear and ensures a longer life and superior performance. The TEC1233 is less noisy, too. The engineers increased power but reduced air consumption and noise. Plus, the Tornador® Black is equipped with sealed ball bearings inside the rotation set. Wear is minimized because the rotation set no longer comes into contact with the cone. This improvement makes the TEC1233 better suited for long term, frequent use, as in a professional detailing capacity.

TEC1233 Each

LIMITED WARRANTY*

TEC1235

Tornador® Blow Gun ●

Available Size(s)

Multi-purpose tool that will reduce detailing time. Designed to blow dust and debris out of hard to reach areas; blow water out of jams and seams. Ideal for interior, exterior and engine areas. The strong, tornado-like funnel of air blasts out dirt and dust quickly and easily. It has the same cone shape as the Tornador® Classic Tool. The cone channels air into a powerful tornado-like motion that quickly lifts dirt and moisture from any surface. The cone covers a larger area than a conventional blow nozzle, yet it is still targeted enough to concentrate tremendous air power right where your vehicle needs it.

TEC1235 Each

Must be used with an air compressor capable of operating between 60 and 90 psi.

LIMITED WARRANTY*

COLOR CODED KEY FOR TOOL USE:

● TornadorMAX® ● Tornador® Classic ● Tornador® Black ● Foam-A-Nator ● Tornador® Velocity Vac ● Tornador® Dry Vac ● Tornador® Blow Gun



TEC1236

Tornador® Velocity Vac

Available Size(s)

TEC1236 Each

One of the latest addition to the Tornador® attachments that we carry. You now have the outstanding cleaning power of a Tornador® with the addition of a powerful wet/dry vacuum. TEC1236 easily attaches to the TEC1233 Tornador® Black Cleaning Gun and a wet/dry vacuum, turning it into a quick, easy-to-use wet/dry vac that will help detailers optimize the time that they spend on the interiors of each car. This new technology combination will make cleaning fabric and carpets quicker and easier than ever. Vacuuming, cleaning & air drying all in one device means time & cost savings for everyone.

IMPORTANT NOTE -- The TEC1236 Tornador® Velocity-Vac is ONLY compatible with the TEC1233 Tornador® Black Cleaning Gun.

Don't forget to order our Technician's Choice chemicals that pair perfectly with the Tornador®! TEC391 Do All Enzyme Cleaner, TEC392 HD Enzyme Spot & Stain Remover & TEC393 Enzyme Deodorizer.

LIMITED WARRANTY*



TEC1237

Tornador® Dry Vac

Available Size(s)

TEC1237 Each

Our latest addition to the Tornador® tools that we carry. The TEC1237 takes your vacuuming to a whole new level. The patented Tornador® ball-bearing rotation quickly lifts dirt and grime from carpet fibers that other vacuums leave behind. The unique shape and technology of the vacuum hood also adds additional suction power to your vacuum. The Velocity Vac Dry easily attaches to an air source and a wet/dry vacuum. This new technology combination will streamline your automotive detailing and reconditioning challenges. It's ideal for use in quick Wash and Vac detailing situations in Car Washes, Body Shops, New Car Get-Ready and other quick detailing jobs.

LIMITED WARRANTY*



TEC1240

Foam-A-Nator™

Available Size(s)

TEC1240 Each

Turn your favorite multi-purpose cleaner or car wash shampoo into a super thick, long-lasting foam. This air-driven foam gun works with your air compressor to produce frothy, rich foam that has amazing cling. Ideal for laying foam that coats and clings to large surfaces. The Foam-A-Nator™ can be used for interior or exterior detailing. Use it with a carpet cleaner or with car wash shampoo to spray a snow storm of foam. The unique barrel on the gun mixes the cleaning fluid and pressurized air to create a blizzard of foam. You'll be amazed! The amount of foam is regulated by a pressure valve on the gun. Use as little foam as you need. Reduce cleaning time with the Foam-A-Nator™. Uses less cleaning fluid and less water consumption than conventional washing. You also have the choice of two diffuser tips for both wide and narrow applications.

LIMITED WARRANTY*



S-100C

Tornador® S-100C Cordless HVLP Spray Gun

Available Size(s)

S-100C Each

Tornador® S-100C is designed for the professional detailer and home enthusiast looking to disinfect, sanitize, deodorize, and/or clean any vehicle, without having to worry about cords.

The S-100C uses High-Volume, Low-Pressure (HVLP) technology to evenly disperse the flow of any liquid with less risk of overspray. The S-100C can also handle viscous products like water-based dressings to make applying dressings easy no matter on the interior or exterior surfaces. Do detail work in less time with the 3 selectable spray patterns: vertical, round, and horizontal. The S-100C is ready to handle whatever the job entails!

Rated power: 120W. **Rated voltage:** 18V (MAX 20V). **Rated speed:** 30000 RPM. **Air flow:** 160 L/Min. **Liquid flow:** 100-200ml/min. **Weight:** 1.6kg. **Battery capacity:** 2000mAh. **Spraying distance:** 200-250mm. **Width:** 200-300mm. **Viscosity:** 8-12 s. **Material pot capacity:** 800ml Comes with 18v/2.0 Ah Li-Ion Rechargeable Battery. Charger. 800mL Container. Funnel. Pin. User's Manual.

Warranty: 1 year internal parts, not wearable parts. 90 days for battery.



S-100BATTERY

Tornador® S-100C 18V Battery

Available Size(s)

S-100BATTERY Each

Replacement 18v/2.0 Ah Li-Ion Rechargeable Battery for the Tornador® S-100C Cordless HVLP Spray Gun.

Rated voltage: 18V (MAX 20V). **Battery capacity:** 2000mAh.

Warranty: 90 days for battery.

***90 day limited warranty against manufacturing & parts defects.**

(Warranty will be voided if it is used for anything other than the intended use of the Tornador® Cleaning Tool. Use of any products, other than approved Tornador® or Technician's Choice® products with the Tornador® Cleaning tool voids warranty.)

Copyright © 2022. ECP, Inc. All Rights Reserved. TORNADOR® and TORNADORMAX® are registered trademarks and may not be used without the prior express written consent of ECP. The TORNADOR product is covered by one or more of the following U.S. patents: 6883732, 8480011, 8690077, 9475071, 10189034, 10343177, 10730062 and/or 10562078.

Always wear recommended safety equipment



EQUIPMENT

Tornador® | Foam-A-Nator Parts

EQUIPMENT



TOOLBAG

Tornador® Tool Bag

Available Size(s)

The Tornador® Tool Bag is the ideal carryall to house your Tornador® tools and detailing products. This rugged, waterproof, padded polyester bag features a zippered, top-load design with durable handles, a padded shoulder strap, and a reinforced bottom. Storage capacity comes complete with 5 large exterior pockets; 2 interior zippered mesh pockets (for polishing pads); 7 interior pockets with elastic straps (for chemicals); 2 interior pockets for batteries; a hook and loop bottom mount strap for securing a buffer or other larger tool. Prominently features embroidered Tornador® badges.

Overall measurements: 21.2" L x 10.2" W x 9.4" H (54cm x 26cm x 24cm)

Color: Black

Material: 600D polyester + 7mm EPE

TOOLBAG Each



183762

Tornador® Service Kit



183769

Tornador® Velocity-Vac Reducer



187662

Tornador® Gasket #28



183764

Tornador® Velocity-Vac Hood Black



183770

Tornador® Velocity-Vac Tube Replacement



187663

Tornador® Spring



183767

Tornador® Velocity-Vac Collar Reducer



183771

Tornador® Velocity-Vac Vac Hose



187664

Tornador® Gasket #18



183768

Tornador® Velocity-Vac Replacement Screw



187562

Tornador® Air Reverse Switch



187665

Tornador® Screw #23



COLOR CODED KEY FOR TOOL USE:

● TornadorMAX®
 ● Tornador® Classic
 ● Tornador® Black
 ● Foam-A-Nator
 ● Tornador® Velocity Vac
 ● Tornador® Dry Vac
 ● Tornador® Blow Gun

EQUIPMENT



187666
Tornador®
Gasket #27



187673
Tornador®
Pin #5



187680
Tornador®
Housing #1



187667
Tornador®
Screw #16



187674
Tornador®
Screw #6



187682
Foam-A-Nator
Screw #14



187668
Tornador®
Nut #19



187675
Tornador®
Screw #8



187683
Tornador®
Blow Gun
Valve Body



187669
Tornador® Black
Rotation Set



187676
Tornador®
Bushing #10



207463
Foam-A-Nator
New Style Head
Attachment



187670
Tornador® Black
Cone



187677
Tornador®
Valve #12



207464
Foam-A-Nator
Diffuser Kit



187671
Tornador® Black
Valve Body



187678
Tornador®
Trigger #7



218261
Tornador®
Valve Body



187672
Tornador® Black
Inner Tube



187679
Tornador®
Screw #9



TEC1222
Tornador®
Repair Kit



Always wear recommended safety equipment



Tornador® / Foam-A-Nator Parts

EQUIPMENT



TEC1223
Tornador®
Cone with Brush



TEC1230
Tornador®
Weighted Tube

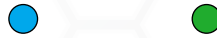

TM-005
TornadorMAX®
Trigger



TEC1224
Tornador®
Cone



TEC1231
Tornador®
Inner Liquid
Tube Fitting



TM-006
TornadorMAX®
Swivel Air Inlet



TEC1225
Tornador®
Replacement Cap



TEC1232
Tornador®
Replacement Cone
with Stainless
Steel Lining

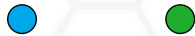

TM-007
TornadorMAX®
Jar



TEC1226
Tornador®
Siphon Tube



TM-001
TornadorMAX®
Housing



TM-008
TornadorMAX®
Jar Cover



TEC1227
Tornador®
Cap without Hole



TM-002
TornadorMAX®
Spring Rotate Set



TM-009
TornadorMAX®
Handle - Black



TEC1228
Tornador®
32 oz. Jar



TM-003
TornadorMAX®
Air Regulator Assembly



TM-010
TornadorMAX®
Handle - Red



TEC1229
Tornador®
Brass
In-Line Regulator



TM-004
TornadorMAX®
LED Light Assembly



TM-012
TornadorMAX®
Handle - Blue



TM-013
TornadorMAX®
Handle Screws



COLOR CODED KEY FOR TOOL USE:

- TornadorMAX®
- Tornador® Classic
- Tornador® Black
- Foam-A-Nator
- Tornador® Velocity Vac
- Tornador® Dry Vac
- Tornador® Blow Gun

For the latest news and up to date product information visit our websites.

- Product Information
- Sell Sheets
- Technical Data Sheets
- Safety Data Sheets (SDS)

VISIT US ONLINE!



www.technicianschoice.net
www.platinumcw.net
www.ecpinc.net



(iPad friendly)



Check us out on social media



Signage

MERCHANDISING



003428

Headlight Restoration Service Windmaster Insert

Available Size(s)

Measures 28" x 44". One sided, full color graphic windmaster insert. Features area for pricing.
 *Standard windmaster frame (PCW560) sold separately (see page 127).
 ** Standard windmaster frames require (2) inserts.

Each



003433

Rid Odor PRO Standard Windmaster Insert

Available Size(s)

Measures 28" x 44". One sided, full color graphic windmaster insert.
 *Standard windmaster frame (PCW560) sold separately (see page 127).
 ** Standard windmaster frames require (2) inserts.

Each



XPC3WND CER MEXT

XPC3 Ceramic Exterior - Standard Windmaster Insert

Available Size(s)

Measures 28" x 44". One sided, full color graphic windmaster insert.
 *Standard windmaster frame (PCW560) sold separately (see page 127).
 ** Standard windmaster frames require (2) inserts.

Each



XPC3WND CER MWHL

XPC3 Ceramic Wheel - Standard Windmaster Insert

Available Size(s)

Measures 28" x 44". One sided, full color graphic windmaster insert.
 *Standard windmaster frame (PCW560) sold separately (see page 127).
 ** Standard windmaster frames require (2) inserts.

Each



003434

Rid Odor PRO Small Banner 48" x 30"

Available Size(s)

Measures 48" x 30". Features metal grommets & strings for hanging.

Each



TECBANNER

"We Proudly Use..." Small Banner 48" x 30"

Available Size(s)

Measures 48" x 30". Features metal grommets & strings for hanging.

Each



XPC3BANNER

XPC3® Large Banner 96" x 30"

Available Size(s)

Measures 96" x 30". Features metal grommets & strings for hanging.

Each



XPC3BANNERSML

XPC3® Small Banner 48" x 30"

Available Size(s)

Measures 48" x 30". Features metal grommets & strings for hanging.

Each



Refer to SDS before use

Ask how you can...

- Control Cost (1 Invoice, 1 Supplier)
- Organize Your "Get Ready" Area
- Maximize Production
- Attain Mobile Flexibility
- Proportion Products Consistently
- Minimize Waste

See also page 104

MERCHANDISING

Over a \$2500.00 benefit installed with a 24 month buy-in commitment.



The Detail Chemical
ORGANIZER + [ECP2201, ECP2202, TEC1260] = **VALUE**

The Detail Chemical Organizer® and Technician's Choice® are registered trademarks of ECP Inc. ©2020.

PAINT CORRECTION

Correct-It Clay System

PAINT CORRECTION



Using the System

Technician's Choice® Correct-It-Clay pad quickly and efficiently removes surface contaminants on new and pre-driven vehicles producing a dynamic new car, showroom shine! Eliminates rail dust and minor paint overspray. Cleans away bugs, road tar and much more. Removes buffing throw off.

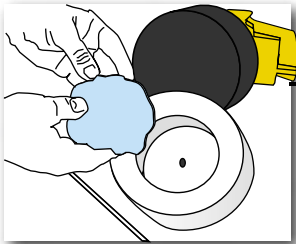

STEP 1

For proper pad, see item TEC1070. Pad cavity should be clean and dry. Press Technician's Choice® clay bar into a flat, oval shape and press firmly into pad cavity.

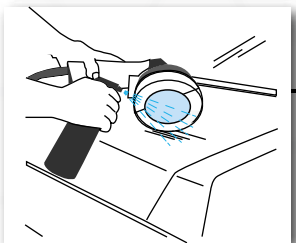

STEP 2

Spray apply TEC506 Correct-It Liquid or TEC510 Correct-It Detailer to approximately a 3' x 3' area on the surface of the vehicle. The surface must be clean and cool.

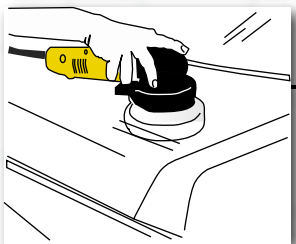

STEP 3

Now "clay" the surface using a recommended polisher (see page 60) operating at 750 to 1500 random orbits per minute. Depending on surface condition, use light to heavy pressure.

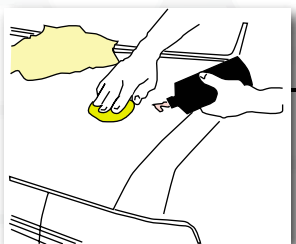

STEP 4

Once you have completed the clay process and you have wiped clean the vehicle's surface, you can complete the process if you desire with your favorite Technician's Choice® polish, wax or sealant.



TEC1070

Correct-It Clay Pad

Designed to hold 180 or 200 gram brick. Velcro® backed to work with all random orbital polishers. Cuts labor time in half!

Available Size(s)

TEC1070 12 pads/case



TEC507

Light Gray Correct-It Clay

Our deluxe fine surface clay bar that safely eliminates rail dust & minor paint overspray on all automotive paint finishes. For best results, use with TEC506 or TEC510. 200 gram brick.

Available Size(s)

Each



TEC160

Clay - Gray (Fine Grade)

A fine grade surface clay bar that safely eliminates rail dust & minor paint overspray on all automotive paint finishes. For best results, use with TEC506 or TEC510. 200 gram brick.

Available Size(s)

Each



TEC511

Purple Gray Correct-It Clay

Our deluxe medium surface clay bar that safely eliminates rail dust & minor paint overspray on all automotive paint finishes. For best results, use with TEC506 or TEC510. 200 gram brick.

Available Size(s)

Each



TEC170

Clay - Red (Medium Grade)

A medium grade surface clay bar that safely eliminates rail dust & minor paint overspray on all automotive paint finishes. For best results, use with TEC506 or TEC510. 200 gram brick.

Available Size(s)

Each



TEC512

Plastic Box for Clay System

Ideal for clay storage. Reuseable & keeps clay fresh.

Available Size(s)

Each

Refer to SDS before use



TEC2750
Medium Grade Clay Mitt

A revolutionary alternative to the clay bar. Features an 8.3" x 6" microfiber mitt with an advanced polymer rubber layer bonded to one side. Just wet the vehicle paint and you can remove all surface embedded contamination faster and more effectively than a clay bar. Can be rinsed and reused numerous times.

Available Size(s)
Each



TEC2760
Medium Grade Clay Towel

Revolutionary alternative to the clay bar. 12x12" microfiber towel with an advanced polymer rubber layer bonded to one side. Fold the towel into a pad and wet the vehicle to remove all embedded surface contamination. Can be rinsed and reused many times.

Available Size(s)
Each



TEC2770
Fine Grade Clay Mitt

Revolutionary alternative to the clay bar. 8.3x6" microfiber mitt with an advanced polymer rubber layer bonded to one side. Wet the vehicle and use this to remove all embedded surface contamination. Can be rinsed and reused many times.

Available Size(s)
Each



TEC2780
Fine Grade Clay Towel

Revolutionary alternative to the clay bar. 12x12" microfiber towel with an advanced polymer rubber layer bonded to one side. Fold the towel into a pad and wet the vehicle to remove all embedded surface contamination. Can be rinsed and reused many times.

Available Size(s)
Each



TEC25
Anti-Static Cleaner/Polish

Easy to use, safe, anti-static formulation to remove finger marks. Use as a clay lubricant. Cleans & polishes paint, glass, chrome, rubber & plastic. Fresh fragrance.

Available Size(s)

- TEC2516CS (6) 16 oz./case
- TEC2504 (4) 1 gal./case
- TEC2505 5 gal./HP
- TEC2555 55 gal./drum



TEC506
Correct-It Liquid

Contains no silicone, wax or hazardous ingredients. Use as a clay lubricant. Works great on all painted surfaces. Grape fragrance.

Available Size(s)

- TEC50616CS (6) 16 oz./case
- TEC50604 (4) 1 gal./case
- TEC50605 5 gal./HP
- TEC50655 55 gal./drum



TEC509
Correct-It Liquid PLUS

Dual function product that can be used in both traditional detailing and the body shop environment. As a detail spray, works well on all exterior surfaces, including paint, glass, chrome, plastic trim and vinyl graphics. Leaves treated surfaces with a slick finish, does not streak, and will not stain trim. The perfect solution for a quick clean up on a slightly dusty vehicle or as a drying aid after washing a vehicle. Can also be used as a premium clay bar lubricant - leaving the surface with a slick feeling. Specially engineered to leave a slick finish, but still be body shop safe.

Available Size(s)

- TEC50932CS (6) 32 oz./case
- TEC50904 (4) 1 gal./case
- TEC50905 5 gal./HP
- TEC50955 55 gal./drum



TEC510
Correct-It Detailer

Water-based, silicone detailer producing a dynamic showroom shine. Removes buffing throw-off. Excellent clay lubricant that works on chrome, glass & dark vehicles without streaking. Developed as a spray on, wipe off formula. Peach fragrance.

Available Size(s)

- TEC51016CS (6) 16 oz./case
- TEC51004 (4) 1 gal./case
- TEC51005 5 gal./HP
- TEC51055 55 gal./drum

Always wear recommended safety equipment

TECHNICIAN'S CHOICE

PROFESSIONAL SERIES

STEP 1

COMPOUNDING

• Heavy Imperfections



TEC548
XPC3® - 1000
Heavy Level



Use any of the suggested pads listed below :

TEC1545
XPC3® Step 1
Level Pad



or

TEC3040
Pre-Washed
Lambswool Pad



or

TEC1525
6" Waffle Pad
Yellow



• Medium Imperfections



TEC549
XPC3® - 1500
Medium Level



• Light Imperfections



TEC550
XPC3® - 2000
Light Level



Designed for use with:
T-21 RO/DA Polisher
T-21C RO/DA Cordless Polisher
TEC1610 E-15 RO/DA Polisher
610461 FLEX RO Polisher



POLISHING

• Micro Imperfections & Polishing



TEC565/32
Micro Glaze
Swirl Remover

• Minor Defects & Polishing



TEC546
XPC3® - Step 2
Polish



• Ceramic Fortified



TEC581
XPC3® - Ceramic
One Step Polish

Visit us on social media



* Always use recommended safety equipment *

PAINT CORRECTION SYSTEM

For New, Used, Auction and Body Shop Cars

STEP
2

Use any of the suggested pads listed below:

TEC1548
5" Euro Pad



or

TEC1549
6" Euro Pad



or

TEC1546
**XPC3® Step 2
Polish Pad**



or

TEC1526
**6" Waffle Pad
Blue**

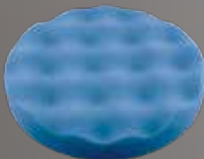

FINISHING

STEP
3

• Protecting



TEC547
**XPC3® - Step 3
Glamour**

Use either of the suggested pads listed below:

TEC1547
**XPC3® Step 3
Glamour Pad**



or

• Finishing



TEC549
**XPC3® - Big Finish
Final Step**

TEC1527
**6" Waffle Pad
Red**



• Finish & Protect



TEC582
**XPC3® - Ceramic
Detail Spray**



Entire Car Protection

Serving the Automotive Industry since 1969
Innovations in Chemistry since 1935

For questions, call ECP Customer Service or visit our website:

www.ecpinc.net • 800-323-3521 • www.technicianschoice.net

ECP Incorporated • 11210 Katherine's Crossing, Suite 100 • Woodridge, IL 60517

Technician's Choice®, Tornador®, XPC3® and ECP® are registered trademarks of ECP Incorporated © 2022.

PRODUCT LINE CARD

PRODUCT LINE



Entire Car Protection

Serving the Automotive Industry Since 1969
Innovations in Chemistry since 1935

Tomorrow's Technology Today

TECHNICIAN'S CHOICE

PROFESSIONAL SERIES



Technician's Choice®, Tornador®, Platinum Professional Car Wash Systems®, Auto Armor® & The Protector® are registered trademarks of ECP Inc.

APPEARANCE & RECONDITIONING



- AEROSOLS
- ADHESIVE
- AIR FRESHENERS
- ALL PURPOSE CLEANERS
- BRAKE CLEANER
- BODY SHOP SAFE
- DETAIL CHEMICALS
- BRUSHES & CHAMOIS
- BUFFING PADS
- CARPET DYE
- CAR WASH
- CLAY • CORRECT-IT SYSTEMS
- CLEANING PRODUCTS
- COMPOUNDS, GLAZES,
- CYCLO POLISHERS
- DEGREASERS
- DETAIL EQUIPMENT
- DISPENSERS
- FINISHING WAXES & SEALANTS
- FACILITY & MAINTENANCE
- FLOOR MATS
- GLASS CLEANERS
- HAND CLEANERS
- HEADLIGHT RESTORATION
- HOT WATER EXTRACTORS
- INTERIOR DRESSING
- LEATHER CLEANERS & CONDITIONERS
- MOPS & SQUEEGEES
- ODOR ELIMINATORS
- ORBITAL POLISHERS
- PAINT & FABRIC PROTECTANTS
- PAPER & PLASTIC PRODUCTS
- PARTS CLEANER
- PRESSURE WASHERS
- PROPORTIONERS
- SAFETY SUPPLIES
- SOAPS
- SPECIALTY PRODUCTS
- TIRE DRESSING
- TOWELS
- UNDERCOATING
- VANDALISM REMOVER
- VARIABLE SPEED BUFFERS
- WAXES
- WHEEL CLEANERS
- WHEEL POLISH
- WINDSHIELD WASHER

PARTS & SERVICE



- AEROSOLS
- BATTERIES
- BULBS
- BULK BRAKE CLEANERS & SOLVENTS
- CARB & CHOKE AND BRAKE CLEANERS
- CURTAIN WALL
- ELECTRICAL CONNECTORS
- ELECTRICAL WIRE
- FLOOR CLEANERS
- FLOOR MATS
- FUEL SYSTEM CLEANERS
- FUEL & VACUUM HOSES
- FUSES
- GLOVES: LATEX & NITRILE
- GREASE
- HAND CLEANERS
- HOSE CLAMPS
- LUBRICANTS
- NUTS & BOLTS
- OIL ABSORBENT PADS
- POWDERED PARTS WASHER CLEANER
- RETAIL PRODUCTS
- SEAT & STEERING WHEEL COVERS
- SERVICE EQUIPMENT
- SPECIALTY WIPES
- SPRAY PAINT
- SURFACE RECONDITIONING SUPPLIES
- TIRE REPAIR
- WHEEL WEIGHTS

Tel: 630.754.4200 Toll Free: 800.323.3521 Toll Free Fax: 800.409.5195

Refer to SDS before use

AUTOMATED CAR WASH



- BANNERS
- BRUSH LUBE
- BUG REMOVER
- CHEMICALS FOR:
TOUCHLESS WASH
TUNNEL
IN BAY
SELF SERVE
- DRYING AGENTS
- DETERGENTS
- METERING SYSTEMS
- ON-LINE DRESSINGS
- PAINT CONDITIONERS
- POINT-OF-PURCHASE
- POWDERS
- PREP SOAPS
- PRESOAKS
- PRODUCTS FOR UPGRADE SALES
- RETAIL PACKAGED CHEMICALS
- RETAIL FRAGRANCES
- RINSE AGENTS
- SIGNS
- SOAPS
- TIRE DRESSINGS
- TOTAL VEHICLE PROTECTANT
- TRIPLE FOAMS
- WAXES
- WHEEL CLEANERS
- WINDSCREENS

Member of ICA, WCA, SCWA & SEMA



www.ecpinc.net

www.platinumcw.net

www.technicianschoice.net

JANITORIAL & FACILITY MAINTAINENCE



- AUTO SCRUBBER PADS
- BATHROOM TISSUE
- BIODEGRADABLE CLEANERS
- DISH DETERGENT
- DISINFECTANTS
- DISPENSING SYSTEMS
- GLASS CLEANERS
- FLOOR CLEANERS
- HAND SOAP
- JANITORIAL CHEMICALS
- JANITORIAL PAPER & SUPPLIES
- LAUNDRY DETERGENT
- PAPER TOWELS
- TOILET BOWL CLEANERS
- TRASH CAN LINERS
- CARPET CLEANERS

VALUE ADDED

- MONTHLY SPECIALS
- EQUIPMENT REPAIR CENTER
- FREIGHT INCENTIVES
- CENTRALIZED PROCESSING
- PRODUCT SATISFACTION
GUARANTEED
- CENTRALIZED PURCHASING
- CAR WASH EQUIPMENT REPORT
- PROFESSIONAL TRAINING PROGRAMS
- TRAINED SALES PROFESSIONALS
READY TO ASSIST YOU
- LABOR SAVING SYSTEMS

Tomorrow's Technology Today
TECHNICIAN'S CHOICE
PROFESSIONAL SERIES

PROUD TO OFFER
OUR CUSTOMERS
PRODUCTS MANUFACTURED
BY THESE TRUSTED
NATIONAL BRANDS



All are trademarks registered
to their respective companies

PAINT CORRECTION

PAINT CORRECTION

XPC3[®] XTREME PAINT CORRECTION SYSTEM



TEC545

XPC3[®] Step 1 Level

Step 1 Level contains solvent cleaners & micro abrasives highly effective & safe in the correction of glamour color & waterbourne paint. Works with both low impact & high impact polishers. When using the XPC3[®] system, Level can remove up to 1500 sandpaper marks even on the softest of glamour colors. To be used with TEC1545 Step 1 Level Pad (pg. 94).

Available Size(s)

TEC54516CS (6) 16 oz./case
TEC54504 (4) 1 gal./case



TEC546

XPC3[®] Step 2 Polish

Step 2 Polish restores color depth to the paint finish safely with no swirls. Removes compound marks with an easy on / easy off process that generates no dust. Safe for all paint finishes when used with the TEC1546 Step 2 Polish Pad (pg. 94).

Available Size(s)

TEC54616CS (6) 16 oz./case
TEC54604 (4) 1 gal./case



TEC547

XPC3[®] Step 3 Glamour

Step 3 Glamour is a silicone fortified, easy on / easy off, non-abrasive, wax free, durable type paint sealant. Contains detergent resistant, amino functional, cross-linking silicone resins to enhance the gloss & color depth of the paint surface. Offers a durable virtually dust-free coating that lasts for up to 12 months. To be used with TEC1547 Step 3 Glamour Pad (pg. 94). Grape fragrance.

Available Size(s)

TEC54716CS (6) 16 oz./case
TEC54704 (4) 1 gal./case



TEC547BS

XPC3[®] Step 3 Glamour - Body Shop Safe

Step 3 Glamour - Body Shop Safe is a non-silicone, oil based finishing step designed to increase color depth & gloss of all painted surfaces. Offers moderate protection with a virtually dust-free finish. To be used with TEC1547 Glamour Pad (pg. 94). Cookie dough fragrance.

Available Size(s)

TEC547BS16CS (6) 16 oz./case
TEC547BS04 (4) 1 gal./case



TEC548

XPC3[®] 1000 - Heavy Duty Leveling Compound

XPC3[®] 1000 will level and polish. Easy to use. It removes heavy imperfections. TEC548 is a blend of high quality dimensioning abrasives and VOC compliant solvents that will allow enough working time to remove 1000 grit scratches from any painted surface, old or new. When used as directed, it will leave the surface leveled, clean and ready for the next step.

Available Size(s)

TEC54816CS (6) 16 oz./case
TEC54804 (4) 1 gal./case

Refer to SDS before use



TEC549

XPC3® 1500 - Medium Leveling Compound

XPC3® 1500 will level and polish. Easy to use. It removes medium imperfections. TEC549 is a blend of high quality dimensioning abrasives and VOC compliant solvents that will allow enough working time to remove 1500 grit scratches from any painted surface, old or new. When used as directed, it will leave the surface leveled, clean and ready for the next step.

Available Size(s)

- TEC54916CS (6) 16 oz./case
- TEC54904 (4) 1 gal./case



TEC550

XPC3® 2000 - Light Leveling Compound

XPC3® 2000 will level and polish. Easy to use. It removes light imperfections. TEC550 is a blend of high quality dimensioning abrasives and VOC compliant solvents that will allow enough working time to remove 2000 grit scratches from any painted surface, old or new. When used as directed, it will leave the surface leveled, clean and ready for the next step.

Available Size(s)

- TEC55016CS (6) 16 oz./case
- TEC55004 (4) 1 gal./case



TEC551

XPC3® Big Finish - Micro Polish/Swirl Remover

XPC3® Big Finish is designed to work as the final step over all leveling / compound products. Easy to use. TEC551 is a blend of high quality fine abrasives, VOC compliant solvents and oils that allow enough working time to remove micro imperfections from any painted surface, old or new. When used as directed, it will leave the surface clean and glossy. Contains UV absorbers.

Available Size(s)

- TEC55116CS (6) 16 oz./case
- TEC55104 (4) 1 gal./case



TEC552

XPC3® Start to Finish - One Step Compound

XPC3® Start to Finish is the complete one step pre-owned vehicle correction / protection product. It cleans, polishes and waxes in one step. Easy to use. TEC552 is a blend of high quality dimensioning abrasives, VOC compliant solvents and carnauba wax that allow enough working time to remove oxidation and micro imperfections from any painted surface, old or new. When used as directed, it will leave the surface leveled, clean, glossy and waxed.

Available Size(s)

- TEC55216CS (6) 16 oz./case
- TEC55204 (4) 1 gal./case

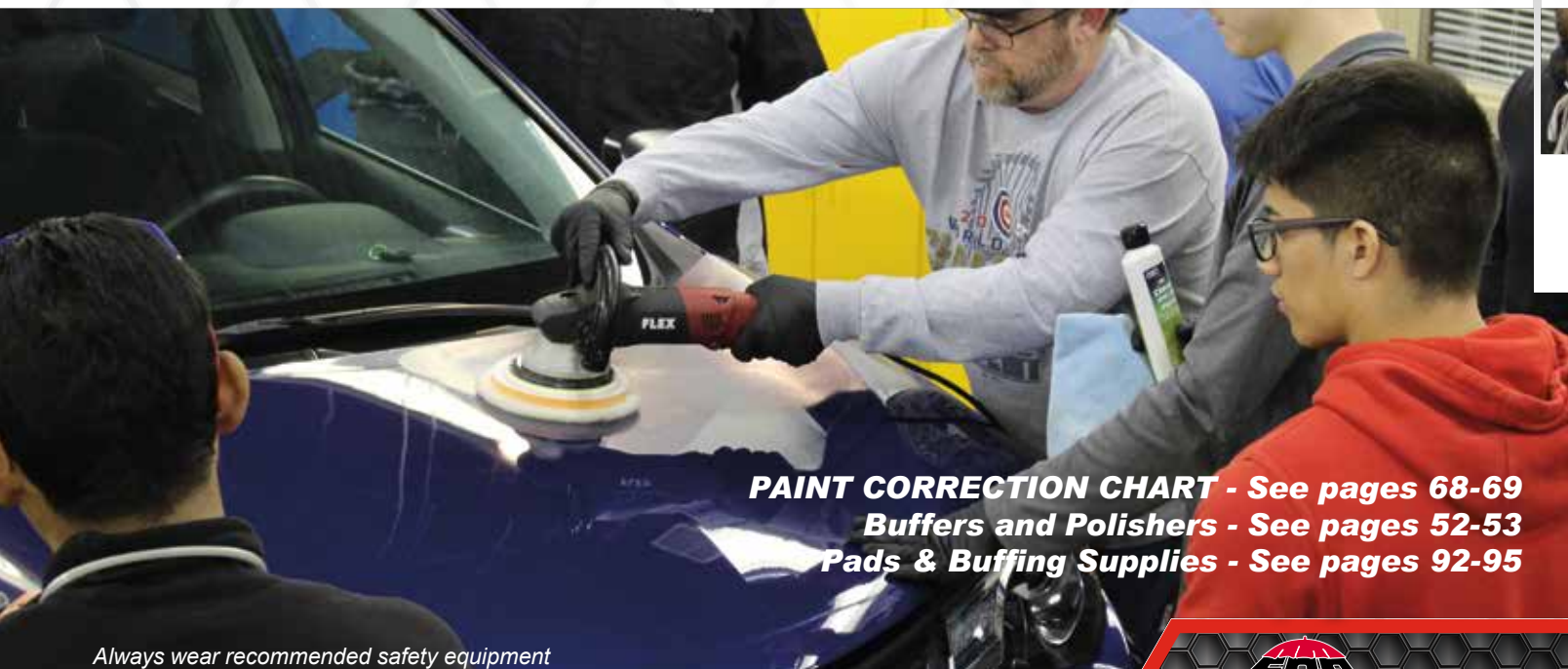

PAINT CORRECTION CHART - See pages 68-69
Buffers and Polishers - See pages 52-53
Pads & Buffing Supplies - See pages 92-95

Always wear recommended safety equipment



PAINT CORRECTION

Compounds, Polishes & Glazes

PAINT CORRECTION



TEC526



Black Cherry Cleaner/Glaze

Non-silicone, oil based cleaner & glaze for removing light oxidation in dark automotive paint finishes. Designed to fill fine scratches, remove minor to moderate paint imperfections & leave an excellent gloss. Cherry fragrance.

Available Size(s)

TEC52616CS (6) 16 oz./case
TEC52604 (4) 1 gal./case



TEC559



Blue Fine Cutting Cream

Fast working cleaner & polish designed to even out color tones, surface imperfections & light oxidation. Removes fine overspray & wetsanding marks up to 1500. Banana/tutti-fruity fragrance.

Available Size(s)

TEC55916CS (6) 16 oz./case
TEC55904 (4) 1 gal./case



TEC565/32



Micro Glaze Swirl Remover

Eliminates scratches & oxidation & buffs to a beautiful luster. Will not smear or swirl black glamour colors. 2000+ grit. Can be used with wool or foam pads or by hand. Strawberry fragrance.

Available Size(s)

TEC565/3216CS (6) 16 oz./case
TEC565/3204 (4) 1 gal./case



Buffers | Polishers - pg. 52-53

Refer to SDS before use

XPC3
XTREME PAINT CORRECTION SYSTEM

CERAMIC



TEC580

XPC3[®] Ceramic Coating

Available Size(s)

TEC580CS (12) 2 oz./case

TEC580 Ceramic Coating is the purest form of surface protection you can apply to your vehicle. Coatings form chemical bonds to the applied substrate, which become both chemically and wear resistant. These chemical bonds are hard to break once cured and give outstanding performance characteristics. The liquid ceramic coating will provide years of protection against all types of environmental attacks. The ceramic resin acts like an additional layer of clear coat which gives increased depth of gloss and enhanced color. Ceramic coating creates an almost non-stick layer on automotive paint surfaces which reduces the adhesion of dirt, grime and bugs. The cured ceramic coating is extremely hydrophobic, chemical & scratch resistant.

Apply to automotive OEM finishes.



TEC581

XPC3[®] Ceramic One Step Polish

Available Size(s)

TEC581CS (6) 16 oz./case

TEC58104 (4) 1 gal./case

TEC581 Ceramic Polish is the first polish to contain ceramic surface material. The polish can be used as a standalone or as an excellent choice for preparing any vehicle's surface for TEC580 or TEC582 application. Ceramic polish contains fine milled polishing agents to give a consistent cut throughout the buffing cycle, while ceramic material is deposited into the pores of the clear coat. This is perfect for light cutting of new & used vehicles. The ceramic material deposited acts as a base layer for additional ceramic application, either liquid or spray. The base layer works synergistically with either the liquid or spray, so there is no need to have an additional prep step prior to additional ceramic application.

Use with TEC3040 Lambswool Pad (pg. 92) and/or TEC1547 Microfiber Pad (pg. 94), or for best results use TEC1548/TEC1549 Euro Microfiber Pad (pg. 94). For easier removal, and best results, use a few sprays of TEC582 Ceramic Detail Spray and a TEC1547 Microfiber Pad.



TEC582

XPC3[®] Ceramic Detail Spray

Available Size(s)

TEC582CS (6) 16 oz./case

TEC58204 (4) 1 gal./case

TEC58205 5 gal./HP

TEC582 Ceramic Detail Spray is one of the easiest ways to get ceramic protection. The product can be used as a standalone, with the Ceramic One Step Polish to aid in removal, or as a Ceramic Coating booster. TEC582 delivers exceptional gloss and slickness to the treated surfaces, along with unparalleled surface protection this can also be used over & over making it a must for express detailing. The product can be used on both wet and dry vehicles. The formula is highly substantive so only a few sprays per panel is needed for adequate coverage. The versatile product can be used on all exterior surfaces, including glass, plastic trim, chrome, moldings, and wheels.

Use with some of our excellent microfiber towels (TEC1206, TEC1207, TEC1208 - see page 107).



TEC583

XPC3[®] Ceramic Wheel Protector

Available Size(s)

TEC58332CS (6) 32 oz./case

TEC58304 (4) 1 gal./case

TEC58305 5 gal./HP

TEC583 Ceramic Wheel Protector is the easiest way to get ceramic surface protection for both OEM and aftermarket wheels. The product once sprayed onto the wheel instantly begins to bond to the surface giving maximum protection and gloss. The treated surface will resist road dirt, grime, and brake dust and make future cleanings easier. The protection is seen with the tight water beading and the wheel will have more luster. The protection will last up to 3 months under normal driving conditions. Easy spray on and rinse off formula.

Prepare wheel surfaces with one of our Technician's Choice tire & wheel cleaners (see pages 42-43).

Always wear recommended safety equipment

PAINT CORRECTION

PAINT CORRECTION

G-MAX[®]

G R A P H E N E



TEC584



G-MAX[®] Graphene Detail Spray

Available Size(s)

G-MAX[®] Graphene Detail Spray features ceramic and graphene infusion to provide superior gloss and protection. TEC584 is the latest in exterior car care. The product takes the ease of use of a detail spray and turns the performance up to 11. Surface slickness is off the charts. Water beading is unstoppable. Gloss is eye piercing. Protection is the max.

TEC584CS (6) 16 oz./case
TEC58404 (4) 1 gal./case

G-MAX[®] Graphene Detail Spray is a versatile product which can be used on all of today's modern vehicle surfaces. The spray and wipe product is effortless and gives whole vehicle protection within minutes. Using G-MAX[®] on your vehicle provides whole vehicle protection for up to 6 months with one application. Maintain that protection by reapplying G-MAX[®] every 6 months. Repeated use of the product builds layers of protection and only enhances the overall look and protective qualities.



TEC585

G-MAX[®] Graphene Coating

Available Size(s)

G-MAX[®] Graphene Coating is the latest evolution in exterior car care. The product takes protection and turns the performance up to 11. Surface slickness is off the charts. Water beading is unstoppable. Gloss is eye piercing. Protection is the max.

TEC585CS (12) 2 oz./case

TEC585 is a professional only graphene ceramic coating, developed to meet the latest standards in car care, while maintaining an easy to use format. There is no need for extended dry times or the use of IR lights. The graphene ceramic coating easily glides over all exterior surfaces, has a long dwell/work time, wipes off effortlessly, and does not streak. Treated surfaces will appear as if they are freshly painted and will look miles deep.

G-MAX[®] Graphene Coating is a dual function molecule which chemically bonds to the clear coat of the vehicle. The formula uses world leading pure silica, combined with graphene, to create the almost impenetrable protective layer. The inorganic end of the molecule forms the hard, chemical bond with the clear coat, while the organic end of the molecule creates the hydrophobic (water fearing) end. This dual functionality allows the clear coat to become resistant to environmental elements, such as acid rain, bird droppings, fallout, and ultraviolet degradation.

Treated surfaces will maintain a beautiful appearance for years and always display a freshly detailed look *when properly maintained. Surfaces will become resistant to dirt/grime buildup and will clean up easier.

VEHICLE PROTECTION
TO THE

MAX[™]

Refer to SDS before use

Looking for...

Fasteners & Hardware or Shop Supplies & Equipment?

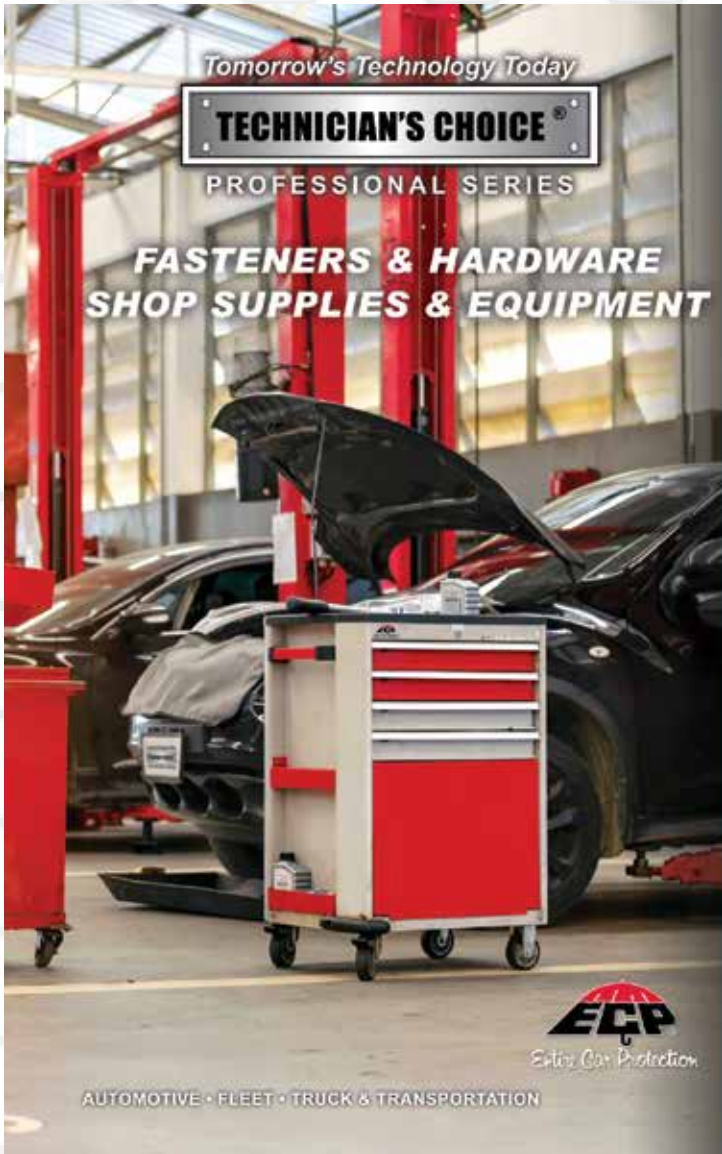

- Cable Ties
- Couplers & Plugs
- Electrical Terminals
- Hood Insulation Clips
- Cap Screws
- License Plate Screws
- Sheet Metal Screws
- Nuts
- Washers
- Miscellaneous Fasteners

- Automotive Lighting
- Batteries & Flashlights
- Fuses
- Grinding & Surface Discs
- Hose Clamps
- Tire Repair
- Wheel Weights

PAINT CORRECTION

www.technicianschoice.net

Download our Fasteners & Hardware, Shop Supplies & Equipment catalog online or request a printed copy.

For more information visit technicianschoice.net or contact us by phone. Our customer service team is ready to assist you!

Call 1-800-323-3251

FOR ALL OF YOUR SHOP SUPPLIES AND EQUIPMENT NEEDS

Always wear recommended safety equipment

Tomorrow's Technology Today

TECHNICIAN'S CHOICE[®]

PROFESSIONAL SERIES



Waxes & Sealants

PAINT CORRECTION



TEC20



Premium Paste Wax

Durable wax containing #1 carnauba wax that provides a long lasting shine. Use on fiberglass, automobiles, watercraft, aircraft & more. Leaves no white residue.

Available Size(s)

TEC20 (12) 13 oz. cans/case



TEC22



Purple Premium Finishing Wax

Versatile product that can be used by machine or by hand. This low abrasive product is designed as a final finish fast wax with quick dry time & a great moisture tolerance. Grape fragrance.

Available Size(s)

TEC2216CS (6) 16 oz./case
TEC2204 (4) 1 gal./case



TEC23



Final Finish

Spray on, wipe off water-based silicone finishing formula that produces a dynamic showroom shine. Works on chrome, glass & dark vehicles without streaking. Cherry fragrance.

Available Size(s)

TEC2322CS (12) 22 oz./case
TEC2304 (4) 1 gal./case
TEC2305 5 gal./HP



TEC24



Express Detailer

Spray on, wipe off water-based silicone formula that results in a high gloss finish for that showroom shine. Works on chrome, glass & dark vehicles. Banana fragrance.

Available Size(s)

TEC2422CS (12) 22 oz./case
TEC2404 (4) 1 gal./case



TEC426



Aqua Glow

Our latest innovation to cut drying time & protect the vehicle. Works on both just rinsed or clean, dry vehicles. Just spray and buff into a high gloss finish. Won't streak, even with a terry cloth towel, lasts up to 4 months & is very easy to apply. Safe for glass or trim as well.

Available Size(s)

TEC42632CS (6) 32 oz./case
TEC42604 (4) 1 gal./case

Refer to SDS before use



TEC513

Quick Yellow Fast Wax

Silicone fortified to help restore color & gloss. Provides a protective, durable coating lasting up to 6 months. Banana fragrance.

Available Size(s)

TEC51316CS (6) 16 oz./case
TEC51304 (4) 1 gal./case



TEC553

Solid Gold Cream Wax

TEC553 is designed to be an all in one product that will clean, shine & seal all in one step. Pairing consistent polishing agents with a blend of polymers guarantees that this product will fill minor imperfections to deliver that perfect shine without a greasy residue. TEC553 Solid Gold has an amazing banana scent & does not contain the traditional harsh solvents.

Available Size(s)

TEC55316CS (6) 16 oz./case
TEC55304 (4) 1 gal./case



TEC578/28

Lightning Polyseal

Wipe on, wipe off formula containing a polymer sealant to quickly remove tar & other road film. Up to 6 months durability. Banana fragrance

Available Size(s)

TEC578/2816CS (6) 16 oz./case
TEC578/2864CS (4) 64 oz./case
TEC578/2804 (4) 1 gal./case



TEC590/95

Ultra Finish

A final step product for protecting automotive paint finishes. For use by hand, or with a high speed or orbital buffer. Increases gloss & color depth. Vanilla fragrance.

Available Size(s)

TEC590/9516CS (6) 16 oz./case
TEC590/9504 (4) 1 gal./case



TEC595

Super Blue Surface Protector

Easy on & off application providing a long lasting protection for all chrome & painted areas. Contains durable silicones for excellent surface coverage. Berry fragrance.

Available Size(s)

TEC59516CS (6) 16 oz./case
TEC59504 (4) 1 gal./case

See page 107 for Microfiber Towels

Service Lane Products

See pages 38-39 for Odor Elimination products

SPECIALTY PRODUCTS



254060

Headlight Restoration Kit

This complete system is everything you need to restore one set of headlight lenses. The coating is ready to go outside in 30 minutes. This kit was designed to help remove the yellowing effect from the lenses that is caused by pollution, contaminants and UV rays from the sun. When used correctly, the Headlight Restoration Kit can help restore polycarbonate lenses to an acceptable clarity.

Available Size(s)

254060CS (12) kits/case



TEC70

TC Black Fusion®

A low viscosity methoxy-methylphenyl oligomer coating that cures at room temperature. May be used on vinyl, polystyrene, rubber & polyvinyl chloride. Restores faded plastic & protects against acid rain, sun damage, chalking & detergents. May be used on car carrier trim, RV trim, truck beds, bumpers & other plastic, black & gray surfaces that are exposed to fading.

Available Size(s)

TEC7002CS (12) 2 oz./case



TEC316

Fuel System Cleaner : Step 1

A concentrated, high tech formula designed to clean the fuel system by dissolving gum, varnish and carbon deposits. This pour in product treats up to 21 gallons of fuel. Recommended use every 5000 miles. Will not hurt catalytic converters.

Gasoline engines only

Available Size(s)

TEC316CS (12) 12 oz./case



TEC317

Induction Cleaner : Step 3

Restores lost power by removing hard deposits from the intake ports, intake valves and combustion chamber. Will not harm fuel system components or catalytic converters. Oxygen sensor safe.

Do not use in rotary engines

Available Size(s)

TEC317CS (12) 12 oz./case



TEC318

Complete Fuel System Treatment Kit

A fuel system tune-up which restores power, performance and fuel economy. Cleans fuel injectors, intake manifold, valves and combustion chamber. Protects against carbon build up and engine knock.

Each kit contains one of the following:

- Step 1: TEC316 Fuel System Cleaner (See above)
- Step 2: TEC99208 - Throttle Body & Air Intake Cleaner (See page 7)
- Step 3: TEC317 Induction Cleaner (See above)

Available Size(s)

6 kits/case (see below for kit contents)

TEC316 (1) 12 oz. bottle/kit
 TEC99208 (1) 4.5 oz can/kit
 TEC317 (1) 12 oz. bottle/kit

Refer to SDS before use

Miscellaneous

SPECIALTY PRODUCTS



ECP380



Heavy Duty Overspray Remover

Quickly & completely removes undercoating & overspray. Emulsifies with water & is safe on paint. Cherry fragrance.

Available Size(s)

- ECP38004 (4) 1 gal./case
- ECP38005 5 gal./HP
- ECP38055 55 gal./drum



TEC90



Remove-All Adhesive Remover

Solvent-based. Removes adhesives, grease & tar. Removes undercoating overspray. Use on vinyl, upholstery & all hard surfaces.

Available Size(s)

- TEC9032CS (6) 32 oz./case
- TEC9004 (4) 1 gal./case
- TEC9005 5 gal./pail
- TEC9015 15 gal./keg
- TEC9055 55 gal./drum



TEC212/87



Super Beads Rinse Agent

SUPER CONCENTRATE. For automatic car wash or hand applications. Improves gloss, water beading & sheeting action. Excellent hard water stability. Cuts chamois time. Biodegradable. Dilute up to 1:300 as a rinse agent; 1:100 as a hot spray wax.

Available Size(s)

- TEC212/8704 (4) 1 gal./case
- TEC212/8705 5 gal./HP
- TEC212/8755 55 gal./drum



TEC311



Southern California Bulk Brake Cleaner

Southern California Bulk Brake Cleaner stands up to the competition and blasts away grease and grime. VOC/OTC Compliant.

Suitable FOR SALE in South Coast Air Quality Management District (AQMD).

Works with our Sure Shot Sprayers and Sure-Fil Filling Systems! (See pages 57 & 105)

Available Size(s)

- TEC31153 53 gal./drum



TEC313



California Bulk Brake Cleaner

California Bulk Brake Cleaner stands up to the competition and blasts away grease and grime. VOC/OTC Compliant.

NOT FOR SALE in South Coast Air Quality Management District (AQMD).

Works with our Sure Shot Sprayers and Sure-Fil Filling Systems! (See pages 57 & 105)

Available Size(s)

- TEC31353 53 gal./drum

Always wear recommended safety equipment



Miscellaneous

SPECIALTY PRODUCTS



TEC314

Blast Off Brake Cleaner

Non-chlorinated solvent blend which provides maximum performance in a brake & parts cleaner without ozone depleting chlorinated solvents.

Works with our Sure Shot Sprayers and Sure-Fil Filling Systems! (See pages 57 & 105)

Available Size(s)

TEC31453 53 gal./drum



TEC315

VOC/OTC Compliant Non-Chlorinated Brake Cleaner

Low VOC, non-chlorinated brake cleaner designed to remove grease & grime without any residual film on brake linings.

Works with our Sure Shot Sprayers and Sure-Fil Filling Systems! (See pages 57 & 105)

Available Size(s)

TEC31505 5 gal./pail
TEC31553 53 gal./drum



TEC307

Traffic Paint Remover

TEC307 Traffic Paint Remover is designed to remove white & yellow traffic paint without damaging most types of automotive surfaces.

Available Size(s)

TEC30732CS (6) 32 oz./case



TEC378

Lacquer Thinner

TEC378 is used for the thinning and clean-up of lacquers and most epoxies. It can be used for cleaning brushes immediately after use.

Available Size(s)

TEC37804 (4) 1 gal./case
TEC37805 5 gal./pail



TEC421

Tool & Parts Cleaner

Removes dirt & residue quickly from tools & parts. Dries fast. Non-chlorinated.

Works with our TEC1066 Sure Shot Sprayer! (See page 105)

Available Size(s)

TEC42153 53 gal./drum

Refer to SDS before use



TEC445
Blue Coat Vinyl Coating

This quick dry, no mess formula protects and enhances exterior and interior vinyl. TEC445 coating helps to prevent fading and cracking while maintaining a natural, dark appearance. The water resistant formula is long lasting and is the finishing touch for a well detailed vehicle. Excellent gloss. Grape fragrance.

Available Size(s)

TEC44505 5 gal./HP
TEC44553 53 gal./drum



TEC495
Parts Cleaner



A metal cleaner developed for removing grease, oil & dirt from aluminum & other non-ferrous metals. Excellent for use in spray washing cabinets, re-circulating tanks & hot dip tank applications.

Available Size(s)

TEC495100 100 lb. drum



TEC497
Paint & Rust Remover



Metal cleaner is a high-quality product for removing grease, oil, dirt & rust from ferrous metal objects.

Available Size(s)

TEC497500 500 lb. drum



TEC649/81
Transportation Coating Remover



CONCENTRATE. Formulated for removing transportation coating from automotive exterior surfaces. Excellent hard water stability. Biodegradable. Dilute up to 1:16.

Available Size(s)

TEC649/8105 5 gal./HP



Always wear recommended safety equipment

Applicators & Scrubbers

SUPPLIES



TEC1003

Knit Wax Applicator Pad

4.5" x 3.5" x 1". Plush pile keeps dirt & grit away from vehicle surface. Machine wash & dry.

Item	Available Size(s)
TEC1003	144/case



ECP1010

Foam Applicator Pad

Poly sponge for applying wax, polish or tire dressing.

Item	Available Size(s)
ECP1010	144/case



TEC1005

Microfiber Coating Applicator Sponge

3.5" x 1.5" x 1.5". This multi-colored microfiber coating applicator sponge has a built-in plastic material layer that helps the prevention of product waste while allowing for easier applications! Made with 80% polyester and 20% polyamide.

Item	Available Size(s)
TEC1005	240/case



TEC1034

Bug Sponge

5" x 7" x 1" netted bug scrubber. Nylon mesh will not tear or snag. Machine washable.

Item	Available Size(s)
TEC1034	120/case



TEC1006

Knit Wax Applicator Pad-Large

6.5" x 4" x 1". Plush pile keeps dirt & grit away from vehicle surface. Machine wash & dry.

Item	Available Size(s)
TEC1006	72/case



TEC1217

Microfiber Sponge with Bug Scrubber

9.75" x 5" x 2.5". Two-sided. One side is soft, non-scratch microfiber, flip for bug scrubber. Two sponges in one.

Item	Available Size(s)
TEC1217	12/case



TEC1007

Foam/Terry Wax Applicator

4" diameter. Foam on one side, terry on the other.

Item	Available Size(s)
TEC1007	144/case



TEC1413

Do-All Scrubber

When used wet, this specially designed honey comb material will carry an abundance of soap & water to safely scrub away stubborn bugs, bird droppings & other contaminants without harming the clear coat. Easily rinses clean.

Item	Available Size(s)
TEC1413	48/case



TEC1008

Round Knit Applicator

4.5" diameter. Terry knit round wax applicator pad. Poly sponge for applying wax, polish & tire dressing.

Item	Available Size(s)
TEC1008	144/case

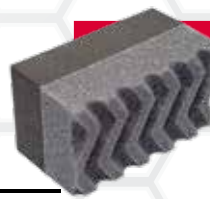

TEC1574

Tire Dressing Applicator Pad

Blended foam Tire Dressing Applicator Pad features wave-shaped ridges for superior spreadability over textured and grooved surfaces, while maintaining even, smooth surface performance. Handle allows for ease of application. Contours with tires and spreads evenly. Minimize runs, drips and waste.

Item	Available Size(s)
TEC1574	24/case

Refer to SDS before use

254060

Find it on page 80!

Headlight Restoration Kit

Yellow or faded headlights can reduce visibility and driving safety at night.

Technician's Choice Headlight Restoration kit is a 2-step process that includes resurfacing plus the application of a unique coating to help restore clarity and brightness to your vehicle's lenses.

Avoid the expense of costly replacements. Technician's Choice Headlight Restoration treatment is long-lasting and cost effective.

This complete system is everything you need to restore one set of headlight lenses. The coating is ready to go outside in 30 minutes. This kit was designed to help remove the yellowing effect from the lenses that is caused by pollution, contaminants and UV rays from the sun. When used correctly, the Headlight Restoration Kit can help restore polycarbonate lenses to an acceptable clarity.



- Restore Clarity
- Increase Visibility & Safety
- Improve Sight Distance
- Improve Headlight Efficiency
- Improve Appearance
- Increase Resale Value
- Easy to Apply



Brushes

SUPPLIES



TEC1011

Wheel/Fender Brush

8" brush with durable flagged yellow synthetic bristles.

Item	Available Size(s)
TEC1011	12/case



TEC1012

21" Wheel/Fender Brush

21" durable synthetic flagged brush.

Item	Available Size(s)
TEC1012	12/case



TEC1013

Brass Tire Brush

8.5" heavy duty brass tire brush.

Item	Available Size(s)
TEC1013	12/case



TEC1014

Nylon Tire Brush

8.5" heavy duty nylon tire brush.

Item	Available Size(s)
TEC1014	12/case



TEC1015

Detail Paint Brush

1.5" detailing paint brush.

Item	Available Size(s)
TEC1015	24/case



TEC1016

Fabric/Floor Mat Brush

8.5" brush, trimmed flat for fabric & floor mats.

Item	Available Size(s)
TEC1016	12/case



TEC1017

All-Purpose Scrub Brush

6" brush on foam plastic block.

Item	Available Size(s)
TEC1017	12/case



TEC1018

Detail Brush

7" horsehair brush with wood handle. Excellent for cleaning small parts, seams & joints.

Item	Available Size(s)
TEC1018	50/case



TEC1019

Detail Brush

7" horsehair detail brush. Cleans small parts, joints & seams.

Item	Available Size(s)
TEC1019	36/case



TEC1032

Vent Brush

6" natural bristles, ideal for interiors.

Item	Available Size(s)
TEC1032	72/case



TEC1033

Upholstery Brush

8.5" horsehair brush for fine upholstery.

Item	Available Size(s)
TEC1033	12/case



TEC1041

Spoke Brush

14" white tampico fiber twisted on rust proof wire.

Item	Available Size(s)
TEC1041	12/case



TEC1073

Wire Wheel/Spoke Brush

6" fiber twisted on rust proof wire.

Item	Available Size(s)
TEC1073	12/case



TEC1074

Short Utility Brush

8.5" nylon utility brush, angled to prevent scraped knuckles.

Item	Available Size(s)
TEC1074	12/case

Refer to SDS before use

TEC1076

Parts/Vent Brush

1" round x 2" trim x 11.75" long. Natural bristles.

Item Available Size(s)

TEC1076 12/case

TEC1077

Small Detail Brush

1.88" trim x 7.56" long. Natural bristles.

Item Available Size(s)

TEC1077 24/case

TEC1078

2-Sided Detail Brush

6.5" long. Natural bristles on one end, black nylon on the other.

Item Available Size(s)

TEC1078 72/case

TEC1085

Multi-Purpose Cleaning Brush

7" double-sided brush ideal for fine detail work & small areas.

Item Available Size(s)

TEC1085 50/case

TEC1086

Brass Sidewall Brush

8.5" brush with brass bristles & a wood handle.

Item Available Size(s)

TEC1086 12/case

TEC1087

White Sidewall Brush

8.5" brush with white nylon bristles & a wood handle.

Item Available Size(s)

TEC1087 12/case

TEC1113

Industrial Paint Brush

Versatile brush great for applying tire dressing, painting fixtures & machinery, etc. 3" black bristles with varnished handle.

Item Available Size(s)

TEC1113 12/case

TEC1114

Economy Paint Brush

Versatile brush great for applying tire dressing, painting fixtures & machinery, etc. 3" white bristles with smooth, sanded handle.

Item Available Size(s)

TEC1114 12/case

TEC1213

Round Upholstery Brush

5" brush for use with high speed buffer / polisher. Comes with a 5/8-11 metal threaded adaptor that allows brush to be attached directly to your Flex or Dewalt variable speed polisher units.

Item Available Size(s)

TEC1213 12 /case

TEC1540

5" Hook & Loop Back Plate

5/16"-24 Thread.

Item Available Size(s)

TEC1540 Each

TEC1572

5" Hook & Loop Carpet Brush

5" dia. brush with 7/8" bristles.

Item Available Size(s)

TEC1572 24 /case

TEC1573

5" Hook & Loop Upholstery Brush

5" dia. brush with 1.5" bristles.

Item Available Size(s)

TEC1573 24 /case

Find Additional Wash Brushes and Mops see page 102!

Always wear recommended safety equipment



Dispensers & Proportioners

SUPPLIES



ECP2000 **Red General Purpose Spray Head**

Rated "BETTER". Fits TEC2100 32 oz. bottle

Item	Available Size(s)
ECP2000	200/case



ECP2001 **Blue General Purpose Spray Head**

Rated "BEST". Heavy duty spray head fits TEC2100 32 oz. spray bottle.

Item	Available Size(s)
ECP2001	200/case



ECP2003 **White General Purpose Spray Head**

Rated "GOOD". Spray head fits TEC2100 32 oz. spray bottle.

Item	Available Size(s)
ECP2003	200/case



ECP2005 **Big Blaster Foamer**

Heavy duty sprayer produces a large volume of clinging foam. Comfort grip.

Item	Available Size(s)
ECP2005	200/case



ECP2006 **Chemical Resistant Trigger Sprayer**

Superior chemical resistance. 40% higher output than standard sprayers. Adjustable nozzle provides the finest mist to jet stream.

Item	Available Size(s)
ECP2006	200/case



ECP2007 **Upside Down Sprayer**

This sprayer works with the spray bottle held at any angle, even completely upside down. This is ideal for reaching tight spots around equipment & works great for auto detailing applications

Item	Available Size(s)
ECP2007	200/case



ECP2008 **Acid Resistant Sprayer**

Superior acid resistance. 40% higher output per stroke reduces the amount of times trigger needs to be pulled. Outer body protects piston assembly to prevent damage during use and storage. Designed specifically for use with acid-based wheel cleaners, also works great with aluminum and stainless steel cleaners.

Item	Available Size(s)
ECP2008	200/case



ECP2009 **Chemical Resistant Sprayer**

Chemical resistant, adjustable nozzle, from spray to stream. Easy grip with a 9.5" tube.

Item	Available Size(s)
ECP2009	100/case



ECP2010 **1-Gallon Spray Head**

Fits directly on a gallon container, eliminating the need for a transfer container.

Item	Available Size(s)
ECP2010	Each



ECP2012 **General Purpose Bulk Spray Head***

Fits TEC2100 32 oz. bottle.
*Colors may vary

Item	Available Size(s)
ECP2012	Each



TEC1046 **Heavy Duty Turbo Sprayer**

High volume jumbo sprayer fits TEC2100 32 oz. bottle.

Item	Available Size(s)
TEC1046	Each

Refer to SDS before use



ECP2201

1-Port Proportioner

Wall mount, 1-port proportioner is ideal for car wash. (4) gallons per minute.

Item	Available Size(s)
ECP2201	Each



ECP2202

1-Port Drum Mount Proportioner

Mounts directly to drum with single port. Ideal for car washes & APC.

Item	Available Size(s)
ECP2202	Each



ECP2203

3-Port Proportioner

Wall mount 3-port proportioner.

Item	Available Size(s)
ECP2203	Each



ECP2300

5 Gallon Jug Dispenser

Three openings for easy fill, pour & store. Complete with caps & 360° spray head.

Item	Available Size(s)
ECP2300	Each



ECP2301

Fill Tube

For ECP2300.

Item	Available Size(s)
ECP2301	Each



ECP2400

Pro Gauge II-Paint Depth Gauge

Accuracy better than 0.001". Easy to use, top & side scale. Longer holding power, heavy-duty case.

Item	Available Size(s)
ECP2400	Each



ECP2401

1oz Pump for Gallon Bottles

Fits standard gallon bottle. Pumps 1 oz. per stroke.

Item	Available Size(s)
ECP2401	Each



TEC122

Gallon Pump Dispenser

1 gal pump used for 4-liter hand cleaners. Can be used in place of using the TEC124 wall dispenser.

Item	Available Size(s)
TEC122	Each



ECP2405

Pump Dispenser

Fits 5 gallon pail up to 55 gallon drum with extension.

Item	Available Size(s)
ECP2405	12/case



TEC1023

3/4" Drum/Pail Faucet

360° spray head.

Item	Available Size(s)
TEC1023	Each



TEC1059

3/4" Faucet

Auto shut off.

Item	Available Size(s)
TEC1059	Each



TEC1218

Plastic Drum Pump

8 oz. delivery per stroke. Polyethylene or polypropylene construction. 3/4" & 2" IPS adaptors & separate pail adaptor. Fits 5 gallon plastic pails & 15, 30 & 55 gallon drums. Telescoping intake tube. Restrictor clips allow for reduced 2 or 4 oz. delivery per stroke.

Item	Available Size(s)
TEC1218	Each



TEC1219

Steel Drum Pump

Large 22 oz. delivery per stroke. Excellent for thicker liquids. Recommended for non-corrosive, non-flammable cleaners and oils. Teflon coated packing seal for solvent resistance. Chrome plating provides resistance to corrosive effects of water-based solutions. 2" IPS adaptor fits 15, 30 & 55 gallon drums.

Item	Available Size(s)
TEC1219	Each



TEC1603

Steel Piston Pump

8 oz. delivery per stroke. 2" NPT bung adaptor fits 15, 30 and 55 gallon drums. Polyethylene piston and steel pump body. 5000 SSU viscosity operation range. Overall length 45". Self-priming 22" suction tube.

Item	Available Size(s)
TEC1603	Each



TEC1604

Polypropylene Piston Pump

8 oz. delivery per stroke. Includes 2-5/8" pail adaptor, 3/4" and 2" drum adapter. For use on 5 gallon pails, 15, 30 & 55 gallon drums. Adjustable stroke from 2, 4, 6 & 8 oz. Self-priming piston drum pump, 5/8" OD / 1/2" ID suction tube. 4000 SSU viscosity operation range. Polyethylene piston and polypropylene body. Repairable Lip Seal. Overall length 43.3". 2" Polypropylene Bung Adapter included.

Item	Available Size(s)
TEC1604	Each

Always wear recommended safety equipment



Miscellaneous

SUPPLIES



TEC1026

16" x 20" Single Weight Sorbent Pad

Universal pad for almost any liquid spill.

Item	Available Size(s)	Pallet Count
TEC1026	200/bundle	(36 bundles/pallet)



TEC1024

16" x 20" Medium Weight Sorbent Pad

Universal pad for almost any liquid spill.

Item	Available Size(s)	Pallet Count
TEC1024	100/bundle	(42 bundles/pallet)



TEC1025

30" x 150' Medium Weight Sorbent Roll

Universal pad for almost any liquid spill.

Item	Available Size(s)	Pallet Count
TEC1025	100/roll	(27 rolls/pallet)



TEC1030

16" x 20" Heavy Weight Sorbent Pad

Universal pad for almost any liquid spill.

Item	Available Size(s)	Pallet Count
TEC1030	100/bundle	(42 bundles/pallet)



TEC1124

16" x 20" Oil Only Sorbent Pad

Oil Only pads do not absorb water & are effective for large or small oil spills or clean-up.

Item	Available Size(s)	Pallet Count
TEC1124	100/bundle	(42 bundles/pallet)



TEC1116

Pet Stone

Removes pet hair quickly & efficiently with its unique texture without damaging the surface. Use the Pet Hair Stone on interior surfaces such as fabric seats, carpets, inside trunks, etc.! PLUS – a dozen other uses outside the vehicle. Environmentally Friendly! TEC1116 is made from 90% post-consumer recycled materials; it's also hypoallergenic and odor free.



Item	Available Size(s)
TEC1116	Each

TEC1055

Floor Mat Clip

Mount directly to wall to allow pressure washing of the floor mat.



Item	Available Size(s)
TEC1055	Each

Unable to find what you need?



Speak with our customer service at
1-800-323-3521

Refer to SDS before use



TEC1021

#9 Heavy Duty Razor Blades

Single edge .009 high carbon steel. Made in USA.

Item Available Size(s)

TEC1021 5000/case



TEC1022

Retractable Window Scraper

Contoured design with retractable blade. Accepts TEC1021 (#9), TEC1079 (#12) and TEC1092 (double-edged plastic) razor blades. Made in USA.

Item Available Size(s)

TEC1022 Each



TEC1029

Mini Scraper

1.5" x 2" with blade. When not in use, reverse blade to sharp edge down. Accepts TEC1021 (#9), TEC1079 (#12) and TEC1092 (double-edged plastic) razor blades.

Item Available Size(s)

TEC1029 Each



TEC1052

Long Razor Scraper

Great for removing stickers and decals, especially when in hard to reach areas. Features a screwdriver style handle with blade storage in handle (replacement blade included). Accepts TEC1021 (#9), TEC1079 (#12) and TEC1092 (double-edged plastic) razor blades.

Item Available Size(s)

TEC1052 12/case



TEC1068

Heavy Duty Utility Knife

High quality for tough use. Retractable blade with blade storage in handle. Accepts TEC1069 Utility Knife Blades.

Item Available Size(s)

TEC1068 Each



TEC1069

Utility Knife Blades

Heavy duty .025 thick utility blades. Fits TEC1068 & all other standard utility knives. Made in USA.

Item Available Size(s)

TEC1069 100/box



TEC1079

#12 Razor Blades

Premium quality single edge blades. Made in USA.

Item Available Size(s)

TEC1079 100/box



Always wear recommended safety equipment



TEC1092

Double-Edged Plastic Razor Blade

Our sharp, double-edge plastic razor blades can be used in a variety of applications. These double-edge blades are completely safe on most surfaces and are sharper than most plastic blades out now.

Item Available Size(s)

TEC1092 100/box



TEC1255

Single-Edged Plastic Razor Blade

Our sharp, single-edge plastic razor blades can be used in a variety of applications. These single-edge blades are completely safe on most surfaces and are sharper than most plastic blades out now. Made in USA.

Item Available Size(s)

TEC1255 100/box



TEC1250

Steel Wool 00

Each pad approximately 3" x 4" x 2.5".

Item Available Size(s)

TEC1250 96/case



TEC1251

Steel Wool 000

Each pad approximately 3" x 4" x 2.5".

Item Available Size(s)

TEC1251 96/case



TEC1252

Steel Wool 0000

Each pad approximately 3" x 4" x 2.5".

Item Available Size(s)

TEC1252 96/case



TEC1057

Steel Wool 00 5 lb. Roll

Each roll is approximately 1/2" thick, 4" wide x 125' long (approx.) and is wound onto a 2" ID core to an outside diameter of about 12"-14".

Item Available Size(s)

TEC1057 Each



Pads & Buffing Supplies

SUPPLIES



TEC1506

Soft Edge Rigid Urethane Back Plate

Velcro® backed, 7" diameter. Rigid fits Control recessed back foam pads & 7 1/2" Wool pad.



Item	Available Size(s)
TEC1506	12/case

ECP1100

Blended Wool Buffing Pad

7.5" light cut pad, 50% twisted & 50% untwisted blended fibers. Velcro® backing.



Item	Available Size(s)
ECP1100	24/case

TEC1507

Soft Edge Flexible Urethane Back Plate

Velcro® backed, 7" diameter. Flexible fits curved edge wool pads.



Item	Available Size(s)
TEC1507	12/case

ECP1101

Wool & Acrylic Pad

7.5" polishing pad with 100% untwisted acrylic & wool. Velcro® attachment.



Item	Available Size(s)
ECP1101	24/case

TEC1510

Universal Back Plate

7" x 5/8 -11 thread, curved edge, hook & loop design.



Item	Available Size(s)
TEC1510	12/case

ECP1103

100% Wool Cutting Pad - Velcro

7.5" heavy cut, 100% twisted wool Velcro® pad.



Item	Available Size(s)
ECP1103	24/case

ECP1112

Wool & Silk Velcro Pad

7.5" polish & cut pad, 100% untwisted fibers, wool & silk blend.



Item	Available Size(s)
ECP1112	12/case

TEC6010

5" Hand Applicator

5" polyurethane foam hand sander / applicator.



Item	Available Size(s)
TEC6010	12/case

TEC3040

Pre-Washed Lambswool Pad

7" 100% lambswool knitted, hook & loop pad with Velcro® back.



Item	Available Size(s)
TEC3040	12/case

Refer to SDS before use

Control Rotary Buffer Foam Pads

IN ORDER OF AGGRESSION



ECP6005

Orange Foam Control Pad

One step orange foam rotary buffer control pad. 9" x 1.5"

Item Available Size(s)

ECP6005 12/case



ECP6004

Yellow Foam Control Pad

Medium cut yellow foam rotary buffer control pad. 9" x 1.5"

Item Available Size(s)

ECP6004 12/case



ECP6003

Green Foam Control Pad

Light cut green foam rotary buffer control pad. 9" x 1.5"

Item Available Size(s)

ECP6003 12/case



ECP6002

Blue Foam Control Pad

Polishing blue foam rotary buffer control pad. 9" x 1.5"

Item Available Size(s)

ECP6002 12/case



ECP6001

Black Foam Control Pad

Final finish black foam rotary buffer control pad. 9" x 1.5"

Item Available Size(s)

ECP6001 12/case



ECP6000

White Foam Control Pad

Final finish white foam rotary buffer control pad. 9" x 1.5"

Item Available Size(s)

ECP6000 12/case



TEC1520

8" Waffle Pad - Yellow

8" x 1.5" Euro Foam pad designed to keep life up & heat down, unique design allows for better air flow during use. Yellow - Heavy Cut.

Item Available Size(s)

TEC1520 36/case



TEC1521

8" Waffle Pad - Green

8" x 1.5" American Foam pad designed to keep life up & heat down, unique design allows for better air flow during use. Green - Medium Cut.

Item Available Size(s)

TEC1521 36/case



TEC1522

8" Waffle Pad - White

8" x 1.5" Euro Foam pad designed to keep life up & heat down, unique design allows for better air flow during use. White - Light Cut/Polish.

Item Available Size(s)

TEC1522 36/case



TEC1523

8" Waffle Pad - Blue

8" x 1.5" American Foam pad designed to keep life up & heat down, unique design allows for better air flow during use. Blue - Polish.

Item Available Size(s)

TEC1523 36/case



TEC1524

8" Waffle Pad - Red

8" x 1.5" Euro Foam pad designed to keep life up & heat down, unique design allows for better air flow during use. Red - Final Finish.

Item Available Size(s)

TEC1524 36/case



TEC1525

6" Waffle Pad - Yellow

6" x 1.5" Velcro® backed, Euro Foam pad designed to keep life up & heat down, unique design allows for better air flow during use. Yellow - Heavy Cut.

Item Available Size(s)

TEC1525 36/case



TEC1526

6" Waffle Pad - Blue

6" x 1.5" Velcro® backed, American Foam pad designed to keep life up & heat down, unique design allows for better air flow during use. Blue - Polish.

Item Available Size(s)

TEC1526 36/case



TEC1527

6" Waffle Pad - Red

6" x 1.5" Velcro® backed, Euro Foam pad designed to keep life up & heat down, unique design allows for better air flow during use. Red - Final Finish.

Item Available Size(s)

TEC1527 36/case

Always wear recommended safety equipment



Pads & Buffing Supplies

SUPPLIES



TEC1544

XPC3® Back Plate

Designed specifically for XPC3® pads with rotary style buffer. 5.5" flexible, Velcro® back plate.

Item Available Size(s)

TEC1544CS 6/case



TEC6012

3" Hook & Loop Back Plate

3" flexible, Velcro® back plate.

Item Available Size(s)

TEC6012EA Each



TEC1545

XPC3® Step 1 Level Pad

6.5" pad designed specifically for use with TEC545 Step 1 Level within the XPC3® Xtreme Paint Correction System. Featuring 1/2" of foam & 1/2" of micro wool the foam acts as a flexible cushion to reduce heat, while the micro wool creates minimal lint & splatter.

Item Available Size(s)

TEC1545CS 6/case



TEC1541

3" XPC3® Step 1 Level Pad

3" pad designed specifically for use with TEC545 Step 1 Level within the XPC3® Xtreme Paint Correction System. Featuring 1/2" of foam & 1/2" of micro wool the foam acts as a flexible cushion to reduce heat, while the micro wool creates minimal lint & splatter.

Item Available Size(s)

TEC1541CS 36/case



TEC1546

XPC3® Step 2 Polish Pad

6.5" pad designed specifically for use with TEC546 Step 2 Polish within the XPC3® Xtreme Paint Correction System. Featuring 1/2" of foam & 1/4" of microfiber. Utilizes firm air cooling foam with circular knitted microfiber. Extreme polishing action to eliminate swirls.

Item Available Size(s)

TEC1546CS 6/case



TEC1542

3" XPC3® Step 2 Polish Pad

3" pad designed specifically for use with TEC546 Step 2 Polish within the XPC3® Xtreme Paint Correction System. Featuring 1/2" of foam & 1/4" of microfiber. Utilizes firm air cooling foam with circular knitted microfiber. Extreme polishing action to eliminate swirls.

Item Available Size(s)

TEC1542CS 36/case



TEC1547

XPC3® Step 3 Glamour Pad

6.5" pad designed specifically for use with TEC547 Step 3 Glamour within the XPC3® Xtreme Paint Correction System. Featuring 1/2" of foam & 1/4" of microfiber. Utilizes firm air cooling foam with circular knitted microfiber. The ultimate in finishing with the highest glamour.

Item Available Size(s)

TEC1547CS 6/case



TEC1543

3" XPC3® Step 3 Glamour Pad

3" pad designed specifically for use with TEC547 Step 3 Glamour within the XPC3® Xtreme Paint Correction System. Featuring 1/2" of foam & 1/4" of microfiber. Utilizes firm air cooling foam with circular knitted microfiber. The ultimate in finishing with the highest glamour.

Item Available Size(s)

TEC1543CS 36/case



TEC1548

5" Euro Microfiber Pad

5" microfiber blend pad featuring 25% lower pile than traditional microfiber pads. Designed for cutting, polishing and finishing. Balanced for all DA polishers. Use with a 5" backing plate. Made in USA.

Item Available Size(s)

TEC1548CS 36/case



TEC1549

6" Euro Microfiber Pad

6" microfiber blend pad featuring 25% lower pile than traditional microfiber pads. Designed for cutting, polishing and finishing. Balanced for all DA polishers. Use with a 5", 5.5" or 6" backing plate. Made in USA.

Item Available Size(s)

TEC1549CS 36/case

Refer to SDS before use



ECP1008

Terry Orbital Bonnet

100% pure terry velour. Machine wash & dry. Fits 10 3/4" to 12" pads.

Item Available Size(s)

ECP1008 Each



ECP1108

Correct-It Foam

Use in place of terry towel to remove polish residue. Machine washable. Dissipates static build-up. Will not scratch clearcoat.

Item Available Size(s)

ECP1108 Each



TEC1009

Mini Orbital Bonnets

Microfiber, machine wash & dry. Fits 6 1/2" foam pads.

Item Available Size(s)

TEC1009 12/case

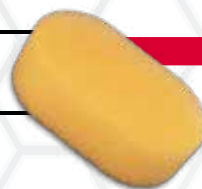

TEC1065

Correct-It Scrubber

Will not scratch paint, glass or chrome. Will remove bugs from all surfaces. Can also be used with solvents to remove hardened tar or adhesives.

Item Available Size(s)

TEC1065 Each



TEC1061

Orbital Buffer Pad - White

6.5" x 1.25". Velcro® backed Polish Pocket™ pad encapsulates polishes to eliminate splatters. Gives operator control over the amount of pad area in contact with the work surface. White Polishing.

Item Available Size(s)

TEC1061 12/case

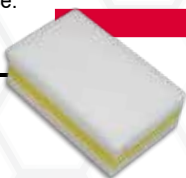

TEC1215

Magician's Sponge

Magically removes stains. Cleans & removes ink marks from leather, scuffs, grime, soap scum, tar, permanent marker, crayon on walls, marks on appliances, bathroom fixtures, floors, dry-erase boards, patio furniture, office equipment & more.

Item Available Size(s)

TEC1215 30/case



TEC1062

Orbital Buffer Pad - Black

6.5" x 1.25". Velcro® backed Polish Pocket™ pad encapsulates polishes to eliminate splatters. Gives operator control over the amount of pad area in contact with the work surface. Black Finishing.

Item Available Size(s)

TEC1062 12/case



TEC1216

Cleaning Sponge

Cleans & removes ink marks from leather, scuffs, grime, soap scum, tar, permanent marker, crayon on walls, appliances, floors & more.

Item Available Size(s)

TEC1216 72/case



TEC1063

Orbital Buffer Pad - Orange

6.5" x 1.25". Velcro® backed Polish Pocket™ pad encapsulates polishes to eliminate splatters. Gives operator control over the amount of pad area in contact with the work surface. Orange One-Step Pad.

Item Available Size(s)

TEC1063 12/case



TEC1004

Wool Pad Spur

Cleans, fluffs & revitalizes pads.

Item Available Size(s)

TEC1104 6/case



TEC1361

Non-Abrasive Hand Pads

6" x 9" pads that are flexible, non-rusting alternatives to conventionally used steel wool. Can be used for general purpose cleaning on any part of the vehicle. These can also be used in kitchens, on countertops and any other surface where scratching would be a concern. They are easy to cut into shapes for jobs and they conform to tight spaces to be used virtually anywhere. Do not use on painted surfaces.

Item Available Size(s)

TEC1361 60/case



ECP1003

Cleaning Brush for Foam Pads

Cleans foam pads easily & effectively between regular washings.

Item Available Size(s)

ECP1003 24/case



TEC1362

Green General Purpose Hand Pads

6" x 9" general purpose hand pads. Recommended for light duty cleaning and finishing application. Accommodates a broad range of performance requirements; ideal for use in food service industries.

Item Available Size(s)

TEC1362 60/case



TEC3050

Pad Washer

System 2000™. Cleans & conditions wool or foam pads in 30 seconds. Portable. Easily adjustable. Your buffer supplies the power.

Item Available Size(s)

TEC3050 Each

Always wear recommended safety equipment



Paper Towels & Toilet Paper

SUPPLIES



TEC1350

Blue Mekanix Wipes

Four-ply. 493' per roll. Fits in TEC1351 Dispenser.

Item	Available Size(s)
TEC1350	2 rolls/case



TEC1351

Mekanix Wipe Dispenser

Center pull, constructed tough for four-ply towels. Hardware included. Will house TEC1350 & TEC1352.

Item	Available Size(s)
TEC1351	Each



TEC1352

Kleen & Prep Wipe

Center pull, two-ply. 965' per roll. Fits in TEC1351 Dispenser.

Item	Available Size(s)
TEC1352	2 rolls/case



TEC1353

Center Pull Towel

Two-ply prep wiper. 600' per roll. Fits in TEC1356 Dispenser.

Item	Available Size(s)
TEC1353	6 rolls/case



TEC1356

Center Pull Towel Dispenser

Use in shop or for general use. Includes hardware. Will house TEC1353.

Item	Available Size(s)
TEC1356	Each



TEC1357

Kitchen Paper Towels

9" x 11" sheets. 85 sheets per roll.

Item	Available Size(s)
TEC1357	30 rolls/case



TEC1359

C-Fold Towels

Multi-fold paper towels.

Item	Available Size(s)
TEC1359	4000/case



TEC1380

Facial Tissue Paper

85 sheets per box.

Item	Available Size(s)
TEC1380	36 boxes/case



TEC1358

Toilet Tissue-Individual

Two-ply. 500' rolls. Safe for septic systems.

Item	Available Size(s)
TEC1358	96 rolls/case



TEC1354

Toilet Tissue

Two-ply. 1000' rolls. Safe for septic systems.

Item	Available Size(s)
TEC1354	12 rolls/case



TEC1355

Toilet Tissue Dispenser

Has 2.4" or 3.38" spindle. Tension adjust to insure correct dispensing.

Item	Available Size(s)
TEC1355	Each

Refer to SDS before use

Plastic & Paper

SUPPLIES



TEC1081

Polyback Floor Mat

17" x 20". 75# plastic coated paper.

Item	Available Size(s)
TEC1081	500/case



TEC1307

DMR Plastic Adhesive Floor Mat

3 mil thickness, 24" x 300'.

Item	Available Size(s)
TEC1307	Roll



TEC1323

Paper Floor Mat

17" x 22"

Item	Available Size(s)
TEC1323	500/case



TEC1308

DMR Plastic Adhesive Floor Mat - L

3 mil thickness, 24" x 600'.

Item	Available Size(s)
TEC1308	Roll



TEC1325

Plastic Floor Mat

16.5" x 21". SNG label.

Item	Available Size(s)
TEC1325	500/roll



TEC1337

DMR Plastic Adhesive Floor Mat - 4 mil

4 mil thickness, 21" x 200' x 24", perforated at 24".

Item	Available Size(s)
TEC1337	Roll



Plastic & Paper

SUPPLIES



TEC1317

SNG Floor Start Up Kit*

Includes (1) each: TEC1319, TEC1325, TEC1322 & 250 each Steering Wheel Double Banded Covers **(These are not currently stocked, available upon request. Stocked item is TEC1326 Shower Cap Cover), 100 Clear Tire Bags **(We currently stock in case quantity of 250; TEC 1327) & 500 each 11"X17" PARTS BAGS** (These are not currently stocked, available upon request. Stocked item is TEC1328 14"X22".)

THIS RACK PROVIDES EXTRA ROOM FOR ADDITIONAL ITEMS, SUCH AS A PAPER OR PREMIUM FLOOR MAT AS SHOWN IN THE PICTURE.

*Special Order Item - Please allow additional time for shipping.

Item	Available Size(s)
------	-------------------

TEC1317	Each
---------	------



TEC1318

SNG Wall Start Up Kit*

Includes (1) each: TEC1320, TEC1325, TEC1322 & 250 each Steering Wheel Double Banded Covers **(These are not currently stocked, available upon request. Stocked item is TEC1326 Shower Cap Cover) and 500 each 11" x 17" Parts Bags **(These are not currently stocked, available upon request. Stocked item is TEC1328 14" x 22")

*Special Order Item - Please allow additional time for shipping.

Item	Available Size(s)
------	-------------------

TEC1318	Each
---------	------



TEC1319

SNG Floor Display Rack

This is the rack from TEC1317, sold unstocked.

Item	Available Size(s)
------	-------------------

TEC1319	Each
---------	------



TEC1320

SNG Wall Display Rack

This is the rack from TEC1318, sold unstocked.

Item	Available Size(s)
------	-------------------

TEC1320	Each
---------	------



TEC1321

SNG Adhesive Display Rack

For use with the TEC1307, TEC1308 & TEC1337 DMR plastic.

Item	Available Size(s)
------	-------------------

TEC1321	Each
---------	------



Refer to SDS before use



TEC1301

Economy Seat Cover

32" x 13" + 43".

Item	Available Size(s)
TEC1301	500/roll



TEC1322

Premium Seat Cover - Roll

Premium seat cover, measures 32" x 13" + 43".

Item	Available Size(s)
TEC1322	250/roll



TEC1335

Premium Seat Cover - Box

Premium seat cover, measures 32" x 13" + 43".

Item	Available Size(s)
TEC1335	250/box



TEC1336

Seat Jacket

Double pocket. Goes over the back of the seat as well as under the seat. Contoured/Fitted. 3 Layer technology insures it stays in place. Fits like/similar to OEM seat covers. One size fits most. Works for new and used vehicle care. Thick & durable. 2 mil (multiple use vs. standard seat covers at .7 mil). Recyclable.

Item	Available Size(s)
TEC1336	Roll



TEC1326

Steering Wheel Cover

Shower cap style. 10 per bundle.

Item	Available Size(s)
TEC1326	500/case



TEC1348

Shift Knob Cover

Clear with no print. 11" x 17".

Item	Available Size(s)
TEC1348	500/roll



TEC1327

Tire Bag

White with no print. 24" + 12" x 40"

Item	Available Size(s)
TEC1327	250/roll



TEC1328

Parts Bag

Clear with no print. 14" x 22".

Item	Available Size(s)
TEC1328	500/roll

Always wear recommended safety equipment



TEC1332

Key Tag - White

Plastic key tag. 4.5" x 7.5"

Item	Available Size(s)
TEC1332	1000/pack



TEC1333

Key Tag - Red

Plastic key tag. 4.5" x 7.5"

Item	Available Size(s)
TEC1333	1000/pack



TEC1347

Key Tag - with Ring

Paper key tag with ring.

Item	Available Size(s)
TEC1347	1000/box



TEC1349

Key Fob Bag

Clear with no print. Resealable. 4" x 2".

Item	Available Size(s)
TEC1349	1000/case



TEC1334

Work/Repair Order Holder

Clear front & back with top open & handle with grommet. Perfect for hanging. 10.5" x 14.5"

Item	Available Size(s)
TEC1334	25/case



TEC1346

Night Drop Envelope

A service form/key drop envelope for the early bird/night owl customers.

Item	Available Size(s)
TEC1346	500/box



TEC1329 -1331 & TEC1339 -1345

Service Numbers

7.5" x 6.5"

Item	Service Numbers	Available Size(s)
TEC1329	#000-999	1000/box
TEC1330	#1000-1999	1000/box
TEC1331	#2000-2999	1000/box
TEC1339	#3000-3999	1000/box
TEC1340	#4000-4999	1000/box
TEC1341	#5000-5999	1000/box
TEC1342	#6000-6999	1000/box
TEC1343	#7000-7999	1000/box
TEC1344	#8000-8999	1000/box
TEC1345	#9000-9999	1000/box

Safety Supplies

SUPPLIES



137961

Safety Glasses

Polycarbonate wraparound lens with a scratch resistant coating. Soft non-slip temple. ANSI Z87.1-2003 certified.

Item	Available Size(s)
137961	Each



TEC1401

Respirator - Medium

Organic Vapor R95

Item	Available Size(s)
TEC1401	12/box



TEC1402

Respirator - Large

Organic Vapor R95

Item	Available Size(s)
TEC1402	12/box



212360

Respirator Replacement Cartridges

Use with TEC1401 & TEC1402.

Item	Available Size(s)
212360	100/case



TECMASK

Disposable Mask

Non-medical mask with filter layer.

Item	Available Size(s)
TECMASK	50/box

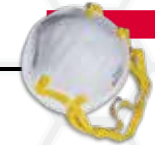

TEC1403

Respirator Particle Mask

NIOSH N95 approved. Durable double-shell construction resists crushing.

Item	Available Size(s)
TEC1403	160/case



TEC1082

Black PVC Gloves 14"

Single dip gloves provide protection when working with liquid chemicals. Smooth surface grip, 14" in length. Fully coated PVC on an interlock knit liner.

Item	Available Size(s)
TEC1082	12 pair/case



TEC1083

Black PVC Gloves 18"

Single dip gloves provide protection when working with liquid chemicals. Smooth surface grip, 18" in length. Fully coated PVC on an interlock knit liner.

Item	Available Size(s)
TEC1083	12 pair/case



TEC1400

Spray Socks

Dry wicking polyester, non-linting. One size fits all, three way stretch. Cool & comfortable.

Item	Available Size(s)
TEC1400	72/box



Refer to SDS before use



TEC1420 -1423
Blue Nitrile Powder-Free Examination Gloves

Best value Nitrile gloves which fit and feel like latex gloves but are non-allergenic and lightweight with superior durability. Made from 100% Nitrile (Latex Free), these gloves are ambidextrous, sky-blue in color, and non-sterile. 4 mil palms and 5.2 mil fingers. Fingertip-textured finish even grips extra-thin objects. Greater chemical resistance compared to other materials and each batch of gloves is air-tested to detect pinholes. These gloves conform and are tested to the highest international standards. Intended for single use only. 100 gloves per box, 10 boxes per case. Chemo-Rated.

Item	Description	Available Size(s)
TEC1420	(S) Small	10/case
TEC1421	(M) Medium	10/case
TEC1422	(L) Large	10/case
TEC1423	(XL) X-Large	10/case



TEC1424 -1427
Black Nitrile Powder-Free Examination Gloves

Black Nitrile powder free examination gloves are made from 100% Nitrile (Non Latex), ambidextrous, fully textured, black color and non-sterile. These gloves conform and are tested to the highest international standards. 5 mil thickness for improved puncture resistance. Intended for single use only. 100 gloves per box, 10 boxes per case. Automated packing to enhance single glove dispensing.

Item	Description	Available Size(s)
TEC1424	(M) Medium	10/case
TEC1425	(L) Large	10/case
TEC1426	(XL) X-Large	10/case
TEC1427	(XXL) XX-Large	10/case



TEC1440 -1442
Powder-Free Textured Blue Nitrile Gloves

Thicker than standard nitrile gloves at 5 mil with 6 mil fingertips. Unsurpassed comfort & outstanding tactile sensitivity. The perfect combination of strength & comfort. 100 gloves per box, 10 boxes per case.

Item	Description	Available Size(s)
TEC1440	(M) Medium	10/case
TEC1441	(L) Large	10/case
TEC1442	(XL) X-Large	10/case



TEC1443 -1446
HD Orange Nitrile Textured Powder-Free Gloves

HD Orange Nitrile Gloves will accommodate every customer you have. These gloves feature an ambidextrous shape and are powder & latex free. A very aggressive texture & standout orange color performs in every condition, wet, dry, oily, sticky & slimy. These are the gloves for your most demanding jobs. Perfect for Automotive, Chemical, Paint & Janitorial. *Thicknesses are within 1mm* Cuff – 6mm, Palm – 8mm, Finger – 10mm.

Item	Description	Available Size(s)
TEC1443	(M) Medium	10/case
TEC1444	(L) Large	10/case
TEC1445	(XL) X-Large	10/case
TEC1446	(XXL) XX-Large	10/case

Always wear recommended safety equipment

Nitrile
Latex



TEC1428 -1431
Micro-Textured Powder-Free Latex Examination Gloves

Micro-textured Powder Free Latex Examination Gloves are made from 100% natural rubber, ambidextrous, creamy beige color and non-sterile. 5 mil palm and 6 mil finger with a beaded cuff for easy removal & tear resistance. Improved quality and purity due to an advanced rinsing process. Each batch of gloves is air-tested to detect pinholes. These gloves conform and are tested to the highest international standards. Beaded cuff for easy removal & tear resistance. Intended for single use only. 100 gloves per box, 10 boxes per case.

Item	Description	Available Size(s)
TEC1428	(S) Small	10/case
TEC1429	(M) Medium	10/case
TEC1430	(L) Large	10/case
TEC1431	(XL) X-Large	10/case



TEC1432 -1436
Powder-Free Textured Heavy-Duty Latex Gloves

8 mil heavy-duty latex gloves are perfect for your toughest jobs! These powder free industrial grade gloves feature a smooth interior for quick, easy donning & a textured surface for an outstanding grip. Economically priced these HD gloves are twice as thick as standard disposable gloves, but still have the dexterity & sensitivity you expect in a latex glove. Beaded cuff for easy removal & tear resistance. The all-around best latex protection for your most valuable tools! 100 gloves per box, 10 boxes per case. Applications & Industries: automotive, industrial manufacturing, janitorial painting & agriculture.

Item	Description	Available Size(s)
TEC1432	(S) Small	10/case
TEC1433	(M) Medium	10/case
TEC1434	(L) Large	10/case
TEC1435	(XL) X-Large	10/case
TEC1436	(XXL) XX-Large	10/case



TEC1437-1439
Powder-Free Textured Heavy-Duty Latex Gloves

Extra strong (15 mil thick) and extra long (12") medical grade gloves provide added protection for the wrist and lower forearm. These HD gloves maintain excellent sensitivity while being twice as thick as standard latex gloves. 50 gloves per box, 10 boxes per case. Applications & Industries: automotive, industrial, manufacturing, janitorial, EMS & medical.

Item	Description	Available Size(s)
TEC1437	(M) Medium	10/case
TEC1438	(L) Large	10/case
TEC1439	(XL) X-Large	10/case

Squeegee, Mops & Brushes



ECP2500

Wash Bucket with Dolly

Includes dirt screen.

Item Available Size(s)

ECP2500 Each



TEC1102

Bi-Level Unflagged Brush

10" block. 2" green polystyrene trim.

Item Available Size(s)

TEC1102 12/case



138961

Grit Guard Insert

Fits 12" diameter buckets. 10.375" dia. x 2.5" tall.

Item Available Size(s)

138961 Each



TEC1203

Magic Mop

Wash cars & trucks effortlessly. Absorbent cotton wash head removes easily. Includes handle, frame & head.

Item Available Size(s)

TEC1203 Each



TEC1035

Premium Car Wash Brush

9" block. 2.5" green nylon trim, flagged. Order with TEC1036 Premium Wood Handle.

Item Available Size(s)

TEC1035 12/case



TEC1204

Magic Mop Head

Cotton with snaps. Replacement head for TEC1203 Magic Mop.

Item Available Size(s)

TEC1204 Each



TEC1093

Wheel Brush

5" block. 2.5" red polypropylene trim.

Item Available Size(s)

TEC1093 12/case



TEC1211

Magic Mop Rubber Frame

Use with TEC1203 Magic Mop.

Item Available Size(s)

TEC1211 Each



TEC1094

Car Wash Brush

10" block. 3" black & white polystyrene trim.

Item Available Size(s)

TEC1094 12/case



TEC1036

Premium Wood Handle

5' length. For use with TEC1035, TEC1093, TEC1094, TEC1099 & TEC1205.

Item Available Size(s)

TEC1036 12/case



TEC1098

20" Utility Brush

20" long, durable blue bristles.

Item Available Size(s)

TEC1098 12/case



TEC1099

Bi-Level Truck Wash Brush

10" block. 2" green polystyrene trim, flagged. Order with TEC1036 Premium Wood Handle.

Item Available Size(s)

TEC1099 12/case



TEC1205

30" Floor Squeegee

Soft foam rubber, double edged squeegee for tough work. Order with TEC1036 Premium Wood Handle.

Item Available Size(s)

TEC1205 10/case

Refer to SDS before use



Towels & Polishing

SUPPLIES



TEC1042

Red Shop Towels

12" x 12" cotton towels. 12 per bag.

Item	Available Size(s)
TEC1042	12 Bags/case



TEC1050

5# Roll Polishing Cloth

5.73 cubic foot general use cloth.

Item	Available Size(s)
TEC1050	Each



TEC1043

100% Cotton Diapers

Measures approximately 13" x 20".

Item	Available Size(s)
TEC1043	100/case



TEC1044

Terry Cloth Towel

15" x 18"

Item	Available Size(s)
TEC1044	72/case



TEC1047

Blue Window Huck Towel

Measures approximately 20" x 24".

Item	Available Size(s)
TEC1047	25 lb. case



TEC1048

1/2 Bath Towels

16" x 27". 100% absorbent cotton loops, excellent for detailing.

Item	Available Size(s)
TEC1048	240/case

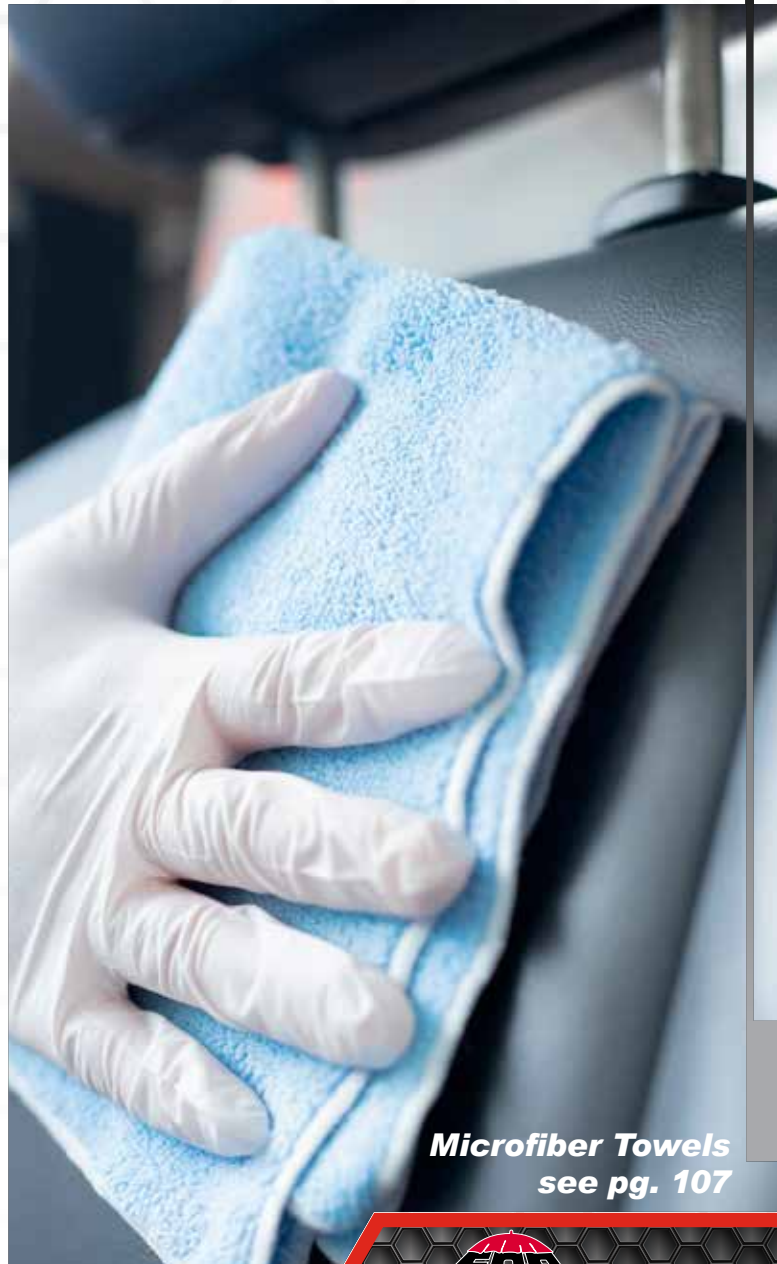

Microfiber Towels
see pg. 107

Always wear recommended safety equipment

Transfer Containers, Sprayers & Racks

SUPPLIES



221661

Adjustable Tray

3.125" h x 18.25" w x 12.25" d. 32 compartment adjustable tray with latches.

Item Available Size(s)

221661 Each



221666

Base for 4 Drawer Rack

Made of heavy duty, cold rolled steel & finished with a durable, powder coat painting process. Coordinating rack for this base is 221662.

Item Available Size(s)

221666 Each



221662

4 Drawer Cabinet Rack

Made of heavy duty, cold rolled steel & finished with a durable, powder coat painting process. Coordinating base for this bin is 221666.

Item Available Size(s)

221662 Each



221667

Base for 72 & 40 Compartment Bins

Made of heavy duty, cold rolled steel & finished with a durable, powder coat painting process. This base coordinates with 221664 - 72 Compartment & 221663 - 40 Compartment Bins.

Item Available Size(s)

221667 Each



221663

40 Compartment Bin

Dimensions: 21-1/2"H x 35-1/4"W x 11-7/8"D. Made of heavy duty, cold rolled steel & finished with a durable, powder coat painting process. Coordinating base for this bin is 221667.

Item Available Size(s)

221663 Each



ECP2306

5 Shelf Rack

Holds (5) ECP2300 5 Gallon Jug Dispensers.

Item Available Size(s)

ECP2306 Each



ECP2310

10 Shelf Rack

Holds (10) ECP2300 5 Gallon Jug Dispensers.

Item Available Size(s)

ECP2310 Each



221664

72 Compartment Bin

Dimensions: 42"H x 35-1/4"W x 11-7/8"D. Made of heavy duty, cold rolled steel & finished with a durable, powder coat painting process. Coordinating base for this bin is 221667.

Item Available Size(s)

221664 Each



TEC1260

The Detail Chemical Organizer™ Cart

Dimensions: 60"H x 36-3/8"W x 28-1/4"D. Heavy duty construction supports all necessary Technician's Choice products. Features spray bottle racks, removable drip tray, heavy duty casters, mount locations for proportioners and more! Technician's Choice sign mounted atop unit measures 9"H x 26"W.

Item Available Size(s)

TEC1260 Each



221665

36 Compartment Bin

Dimensions: 42"H x 17-5/8"W x 11-7/8"D. Made of heavy duty, cold rolled steel & finished with a durable, powder coat painting process.

Item Available Size(s)

221665 Each

See page 65 for The Organizer program.

Refer to SDS before use



TEC1020
12 oz. Squeezable Bottle

Pours cleaners directly onto the surface.

Item	Available Size(s)
TEC1020	Each



TEC2100
32 oz. Spray Bottle

Graduated measurement for use with many cleaners.

Item	Available Size(s)
TEC2100	75/case



TEC1000
2 Quart Sprayer

Pressurized sprayer delivers fast when working with water-based degreasers, APC & carpet/upholstery stain repellent.

Item	Available Size(s)
TEC1000	Each



TEC1084
Aqua-Foamer Sprayer

Gun/hose attaches to Aqua-Foamer to produce thick, rich foam for more cling time. On/off function, quick rinse.

Item	Available Size(s)
TEC1084	Each



TEC1066
Black Sure Shot

Pressurized sprayer to apply brake cleaner. Adjustable nozzle to control spray.
(See page 57 for Sure-Fil Fill System and Filler Cap Adaptor).

Item	Available Size(s)
TEC1066	Each



559472
Sure Shot Atomizer

Pressurized 16 oz. sprayer to apply brake cleaner. Electroless Nickel plated aluminum sprayer with a brushed finish and chrome plated brass top.
(See page 57 for Sure-Fil Fill System and Conversion Kit).

Item	Available Size(s)
559472	Each

Need safety labels for transfer containers?

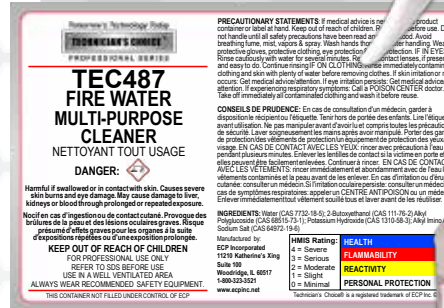

More Safety Label information pg. 132 or call our Customer Service team at -

1-800-323-3521

Bulk Brake Cleaners pg. 81-82



Wash & Dry



TEC1031

Premium Synthetic Chamois

720 square inch.

Item Available Size(s)

TEC1031 12/case



TEC1051

No Cuff Wash Mitt

Measures approximately 8" x 10".

Item Available Size(s)

TEC1051 24/case



TEC1045

Fireman's Friend Chamois

460 square inch. Comes in a tube.

Item Available Size(s)

TEC1045 Each



TEC1089

Synthetic Wash Mitt

Measures approximately 8" x 12" (including the cuff). Synthetic fleece.

Item Available Size(s)

TEC1089 12/case



TEC1049

Premium Synthetic Chamois - Large

791 square inch.

Item Available Size(s)

TEC1049 24/case



TEC1090

Synthetic Wash Mitt with Bug Remover

Measures approximately 7" x 10" (including the cuff). Netted on one side for bugs and tar, synthetic fleece on the other.

Item Available Size(s)

TEC1090 24/case



TEC1056

Premium Synthetic Chamois - Small

559 square inch.

Item Available Size(s)

TEC1056 12/case



TEC1550

Premium Standard Wash Mitt

Measures approximately 12" x 8" (including the cuff). 100% American made & assembled.

Item Available Size(s)

TEC1550 24/case



TEC1075

Hand Wringer

Tough, rugged for detail shops & car washes.

Wring out chamois, mitts, towels & more.

Replacement rollers are: 576362 Top or 576363 Bottom.

Item Available Size(s)

TEC1075 Each



TEC1551

Premium Oversized Wash Mitt

Measures approximately 12" x 9.5" (including the cuff). 100% American made & assembled.

Item Available Size(s)

TEC1551 24/case

Refer to SDS before use



TEC1206

Microfiber Waffle Towel

16" x 16". Premium ultra-soft drying towel – all the benefits of our current microfibers and more. The waffle weave grooves trap water and liquids with great absorption. Durable design to withstand washing. Stitched edges to reduce scratching.

Item	Available Size(s)
TEC1206	50/case



TEC1256

Fireman's Nozzle

This nozzle features large rubberized spray head, heavy duty metal construction, an adjustable spray from extra wide to blasting flow. A versatile product useful in any location!

Item	Available Size(s)
TEC1256	12/case



TEC1207

Microfiber Towel - Yellow

16" x 16". Use to wax, great for detailing & dusting.

Item	Available Size(s)
TEC1207	50/case



TEC1261

Standard 50' Water Hose

This hose measures 5/8" I.D. by 50' long and features a SwivelGrip handle on the female end, a Hybrid Polymer Blend material inner tube (drinking water safe) and an abrasion-resistant outer cover. Offers cold-weather flexibility and won't kink under pressure.

Item	Available Size(s)
TEC1261	Each



TEC1208

Microfiber Towel - Blue

16" x 16". Great for windows.

Item	Available Size(s)
TEC1208	50/case



TEC1209

Microfiber Towel - Yellow Large

16" x 36". Use to wax, great for detailing & dusting.

Item	Available Size(s)
TEC1209	50/case



TEC1262

Premium 50' Water Hose

Measuring 5/8" I.D. by 50' long, this hose was engineered with a lightweight Premium Hybrid Polymer material to lie flat (no memory) and eliminate kinking; offers extreme all-weather flexibility. It features crush resistant anodized aircraft aluminum male and female fittings, a superior female hose end O-ring seal, a Premium Hybrid Polymer Blend material inner tube (drinking water safe) and an abrasion-resistant outer cover.

Item	Available Size(s)
TEC1262	Each



TEC1210

Microfiber Towel - Bulk

16" x 16". Assorted colors.

Item	Available Size(s)
TEC1210	200/case



TEC1270

Heavy Weight Microfiber Towel - Orange

16" x 24". Heavy weight with hi/low knapp. Individually bagged.

Item	Available Size(s)
TEC1270	50/case



TEC1271

Two-Sided Microfiber Towel

16" x 24". Individually bagged.

Item	Available Size(s)
TEC1271	50/case



TEC1214

Quic-Dry Vehicle Dry Blade

All plastic, won't scratch. 12.25" long with a flexible, see-through plastic 2.5" blade. Now can be used with our TEC1036 5' Wood Handle for large vehicles and trucks. Another option is to use this with the TEC1036 as a snow broom.

Item	Available Size(s)
TEC1214	Each

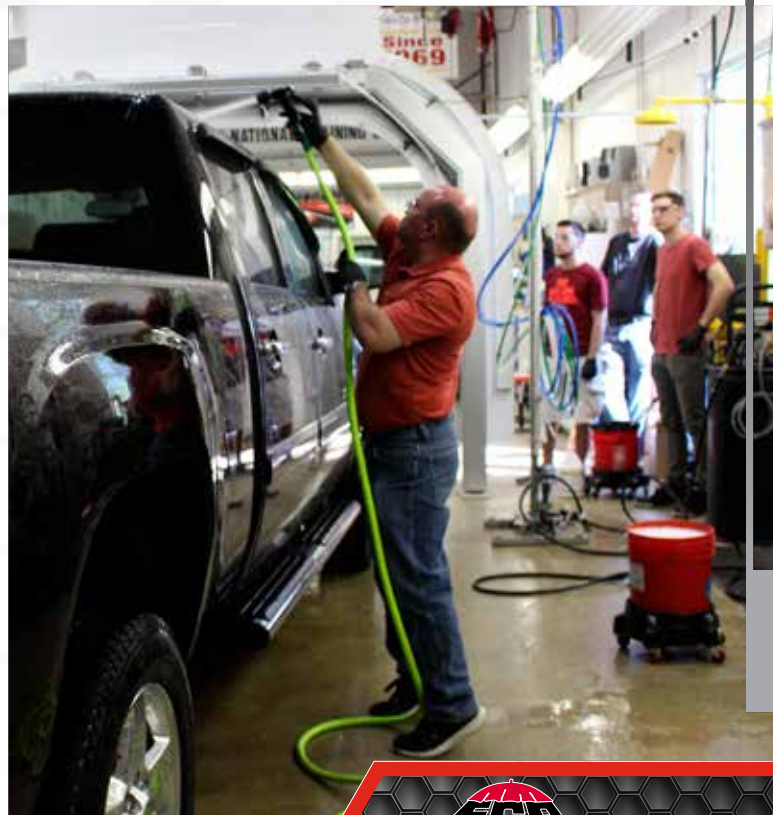

Always wear recommended safety equipment



Entire Car Protection

*Serving the automotive industry since 1969
Innovations in chemistry since 1935*

At ECP we believe in product knowledge. For the technician, our hands-on training teaches the latest in techniques, tools and emerging products and systems.

If you are directly or indirectly in sales, you know that understanding your product line arms you with the ammunition to be convincing, persuasive and successful in your presentations.

ECP's training programs arm you with the product information, product knowledge and product understanding of all our profit building and cost saving programs.

Knowledge - the path to higher levels of sales and profit opportunities.

As a manufacturer, ECP carries multiple products for your type of application. With our hands on training, product and application knowledge, we can help you determine what product(s) can be most effective in your place of business.



We don't talk about training - we deliver verifiable results, either at our modern, innovative 7200 sq. ft. National Training Center or remotely at your place of business.



NATIONAL TRAINING CENTER CLASSROOM COURSES PUT YOU TO THE TEST

Overview of Training Curriculums:



ECP provides a variety of comprehensive training courses complete with training kits and certificates of completion.



Tomorrow's Technology Today

TECHNICIAN'S CHOICE
 PROFESSIONAL SERIES

**Appearance & Reconditioning /
 Prep & Service Chemicals**
Automotive, Fleet, Truck & Transportation

Dealer Class 101:

- Intro to Reconditioning of Used Vehicles & Retail Details
- Intro to New Vehicle Get Ready Process
- Intro to Paint Correction Procedures
- Interior Detailing & Spot Removal including Odor Control
- Basic Product Selection
- Basic Safety Training

Dealer Class 102:

- Explore Labor Saving Processes & Techniques
- In-Depth Paint Correction Procedures
- How to Organize Your Prep Department – Saving You Time & Money
- In Depth Product Selection Training
- How to Control Cost & Usage

Dealer Class 103: MASTER TECHNICIAN

- Earn your Master Technician certification!
- The highest level of dealer training available. Review and master techniques, paint correction, product selection and more!
- Must have attended Dealer 101 & 102 classes to qualify

Distributor Class 101:

- Dealer Training Course (Overview)
- New Product Demos – Features & Benefits
- Promotions / Packages
- Hands-On Training
- Set Up Territories & Routes
- Checks & Balances – Monitor Your Success
- Programs to Generate Success

Distributor Class 102:

- Advanced Paint Correction Techniques
- Advanced Interior Correction
- Labor Saving Programs
- How to Handle Difficult Customers & High Demand Situations

Distributor Class 103: "Train the Trainer"

- Earn your Master Trainer certification!
- This course was developed to provide you with top level training and certification. Attendees will leave here with the ability to provide their customers with the highest level of training wither on-site or at their locations.
- Must have attended Distributor 101 & 102 classes to qualify

PLATINUM
 PROFESSIONAL CAR WASH SYSTEMS®

Commercial Car Wash Products

Course:

- Tunnel Washes
- In-Bay Automatics, Rollovers, Touchless & Friction
- Sales Training
- The Methods of Volumetrics
- Customer Service Advisor (CSA)
- Titration

**Protective Coatings
 Optional Protection Products
 Menu Selling Systems**

WHILE HANDS-ON COURSES TEACH YOU METHODS THAT ARE PROVEN.



Table of Contents

Products (by category)	PAGE(S)
Pre-Soaks	112-113
Alkaline (High pH)	112
Neutral pH • Acidic (Low pH)	113
Brake, Wheel & Whitewall Cleaners	114
Soaps & Detergents	115
Tri-Foam Polishes & Conditioners	116-117
Polishes / Conditioners • Foamy Lubes	116
FASTBREAK (High pH) • FASTBREAK (Low pH)	117
Rinse Agents & Protectants	118-120
Drying Agents • TVP • Protectants	118
Lava Waxes	119
Platinum Ceramic Shield®	120
Tire Dressings - Water Based • On-Line	121
Specialty Products	122-123
Bug Removers • Tunnel & Equipment Cleaner • Laundry Detergent & more	122
Fragrance Boosters	123
Equipment	124-125
Dosatrons • Regulator • Proportioners	124
Titration Kit • Graduated Cylinders	125
Signage	126-129
Banners	126
Windmasters & Frames	127-128
Cones & Drum Covers	129
Tables & Charts	130-131
PCW INDEX	136-137
Product Use Guide	138-139

Usage Symbols (PCW)

Our products are formulated for use in various types of wash applications. Use the legend below to help reference the symbol associated with each product. These symbols identify which specific wash application(s) are best suited for the respective products.

T **Tunnel Wash**
 Products that feature this symbol are formulated for use in tunnel wash applications.

A **In-Bay Automatic, Rollover, Touchless & Friction Wash**
 Products that feature this symbol are formulated for use with in-bay automatic, rollover, touchless and friction wash applications.

S **Self-Service Car Wash**
 Products that feature this symbol are formulated for use in self-service wash applications.

If you can't find what you're looking for or don't see what you want, please call our Customer Service.

Call: 1.800.323.3521

PROFESSIONAL CAR WASH SYSTEMS CATALOG • 6TH EDITION

PLATINUM

PROFESSIONAL CAR WASH SYSTEMS®

“Take Your Customers PLATINUM!”™

Pre-Soaks

Alkaline (High pH)

PCW8 TNT High pH Presoak

TAS



Concentrate. High foam presoak. Great high pressure soap for hand guns, self-serve and tunnel car washes. Use in 1st presoak arch of conveyor car wash system. Biodegradable. Cinnamon fragrance. Dilute up to 1:200.

Available Size(s): 5, 15, 30, 55 gallons

PCW52 Film Fighter High pH Presoak

TAS



Concentrate. High foam presoak. Great high pressure soap for self serve car wash. Use in 1st presoak arch of conveyor car wash system. Can be used for prep gun application in tunnel car wash. Biodegradable. Cinnamon fragrance. Dilute up to 1:120.

Available Size(s): 5, 15, 30, 55 gallons

PCW18 Take Off High pH Presoak

TAS



Concentrate. High pH liquid presoak. Easily breaks down road film, windshield wiper residue and road soils. Use as a low pressure presoak application in frictionless or hybrid type systems. Great for prep gun application in tunnel car wash. Great lemon fragrance. Biodegradable. Dilute up to 1:150.

Available Size(s): 5, 30, 55 gallons

PCW36 Foamy Lube Detergent

TAS



Concentrate. Unique liquid detergent that combines alkalinity for cleaning and copious foam for visual appeal. Viscous product provides tremendous lubricity and high foam levels. Makes cloth quiet. May be applied through a foamer or directly on cloth or bristle. Biodegradable. Dilute up to 1:640.

Available Size(s): 5, 15, 30, 55 gallons

PCW19 Premium Presoak Powder

TAS



Concentrate. Quality product for removing road film and soil build-up from automotive and other hard surfaces. Produces abundant foam for increased contact time on vertical surfaces. Special builders, surfactants and solvents lift dirt and grime. 50lbs. makes 55 gallons then dilute up to 1:10.

Available Size(s): 50, 100 lb. drums

PCW84 Foamy Lube GOLD

TAS



Concentrate. A unique liquid detergent that combines alkalinity and water miscible solvents to clean, degrease and generate high foam for visual appeal. It is a viscous product that will provide tremendous lubricity and high foam levels. May be applied through a foamer or directly on to cloth or bristle. Cherry fragrance. Biodegradable. Dilute up to 1:640.

Available Size(s): 5, 15, 30, 55 gallons

PCW31 Vanish High pH Presoak

TAS



Concentrate. High pH liquid presoak. Great in hard water applications. Easily breaks down road film, windshield wiper residue and road soils. Use as a low pressure presoak application in frictionless or hybrid type systems. Great for prep gun application in tunnel car wash. Biodegradable. Dilute up to 1:240.

Available Size(s): 5, 15, 30, 55 gallons

PCW85 Foamy Lube RED

TAS



Concentrate. A unique liquid detergent that combines alkalinity and water miscible solvents to clean, degrease and generate high foam for visual appeal. It is a viscous product that will provide tremendous lubricity and high foam levels. May be applied through a foamer or directly on to cloth or bristle. Cherry fragrance. Biodegradable. Dilute up to 1:640.

Available Size(s): 5, 15, 30, 55 gallons

PCW32 Buffered High pH Presoak

TA



Concentrate. High pH liquid presoak. Use as a low pressure presoak application in frictionless, hybrid type systems, truck wash and all rollovers. Will not stain polished aluminum. Biodegradable. Dilute up to 1:100.

Available Size(s): 5, 15, 30, 55 gallons

PCW86 Foamy Lube BLUE

TAS



Concentrate. A unique liquid detergent that combines alkalinity and water miscible solvents to clean, degrease and generate high foam for visual appeal. It is a viscous product that will provide tremendous lubricity and high foam levels. May be applied through a foamer or directly on to cloth or bristle. Cherry fragrance. Biodegradable. Dilute up to 1:640.

Available Size(s): 5, 15, 30, 55 gallons

Pre-Soaks

Neutral pH

Pre-Soaks

Acidic (Low pH)

PCW15 Super Foamer Neutral pH Presoak T A S



Concentrate. High foam presoak. Great high pressure soap for hand guns, self-serve and tunnel car washes. Use in 1st presoak arch of conveyor car wash system. Biodegradable. Fresh air fragrance. Dilute up to 1:640.

Available Size(s): 5, 15, 30, 55 gallons

PCW14 Easy Rinse Low pH Presoak T A



Concentrate. First step low pH presoak for touchless cleaning. Great suds and lubricity. Great presoak for tunnel car washes. Built in lubricators quiet mitters and wrap cloth. Brightens chrome and glass. Biodegradable. Dilute up to 1:540.

Available Size(s): 5, 30, 55 gallons

PCW23 Shiner High Foaming Low pH Presoak T A



Concentrate. First step low pH presoak for touchless cleaning. Great suds and lubricity. Great presoak for tunnel car washes. Built in lubricators quiet mitters and wrap cloth. Brightens chrome and glass. Cherry fragrance. Biodegradable. Dilute up to 1:540.

Available Size(s): 5, 15, 30, 55 gallons

PCW33 Citrus Foam Low pH Presoak T A



Concentrate. First step low pH presoak for touchless and conveyor car washes. Great suds and lubricity. Brightens chrome and glass. Biodegradable. Citrus fragrance. As a low pH presoak, dilute up to 1:540.

Available Size(s): 5, 15, 30, 55 gallons

PCW53 Innovation Low pH Presoak T A



Concentrate. First step low pH presoak, great suds and lubricity. Brightens chrome and glass. Biodegradable. Cherry fragrance. Dilute up to 1:240.

Available Size(s): 5, 15, 30, 55 gallons

PCW101 Blue Citrus Foamy Lube T A S



Concentrate. First step low pH presoak, ideal for touchless and conveyor car washes. Contains both natural and synthetic cleaners to deliver outstanding performance. Degreasing is achieved with d-limonene, while industrial co-solvents attack additional stubborn soils. High levels of chelating agents give great hard water stability. 100% active surfactants allow for great foam profiles at high dilution rates. Citrus fragrance. Biodegradable. Dilute up to 1:540.

Available Size(s): 5, 15, 30, 55 gallons



Brake, Wheel & Whitewall Cleaners

Note: All of our Wheel Cleaners should be applied to wet rims, wheels or tires.

PCW7 Foaming Tire Cleaner

TAS



Concentrate. Tough non-acid wheel, white wall tire and engine cleaner. Slightly buffered to control cleaning ability. Works well in warm climates, hard water. Highly recommended for self service car washes. Fluorescent green for vibrant green color. Spearmint fragrance. Biodegradable. Dilute up to 1:23.

Available Size(s): 5, 15, 30, 55 gallons

PCW30 Terminator

TA



Concentrate. Whitewall / wheel and rim cleaner; a non-acid formula that is very aggressive on wheel dust and whitewalls. Excellent foam levels. Fast acting. Biodegradable. Dilute up to 1:25 in warm seasons, up to 1:10 in cold seasons.

Available Size(s): 5, 15, 30, 55 gallons

PCW79 Terminator II - Powered Up

TA



Concentrate. Non-abrasive whitewall / wheel and rim cleaner; a non-acid formula that is very aggressive on brake dust and whitewalls. Excellent hard water and freeze/thaw stability. Phosphate free. Biodegradable. Dilute up to 1:45 in warm seasons, up to 1:20 in cold seasons.

Available Size(s): 5, 15, 30, 55 gallons

PCW24 WOW! Whitewall & Wheel Cleaner

TA



Concentrate. Combination whitewall and wheel cleaner that is highly dilutable and safe on all whitewall tires and wheels. Biodegradable. Dilute up to 1:16.

Available Size(s): 5, 15, 30, 55 gallons

PCW25 BAM! Tire & Wheel Cleaner

T



Concentrate. Non-caustic, non-butyl liquid tire cleaner. Safe on painted and aluminum surfaces. Leaves whitewalls sparkling white. Excellent for C.T.A. application. Biodegradable. Dilute up to 1:8.

Available Size(s): 5, 55 gallons

PCW29 Purple Magic Wheel Brightener

T



Concentrate. Industrial strength, Ammonium Bifluoride based cleaner. Designed to effectively clean and brighten today's wheels. Removes tarnish, brake dust and rust from clear-coated wheels. Do not use on plastic or polished aluminum wheels. Cherry fragrance. Biodegradable. Dilute up to 1:17.

Available Size(s): 5, 15, 30, 55 gallons



Soaps & Detergents

PCW15 Super Foamer

TAS



Concentrate. Designed for cloth in conveyor car washes. High foam, great lubricity and neutral pH. Economical multi-use product. Recommended for the neo glide foam cloth or all soft foam type cloth on the market. Fresh air fragrance. Biodegradable. Dilute up to 1:640.

Available Size(s): 5, 15, 30, 55 gallons

PCW49 Cherry Foam Brush

S



Concentrate. Specially formulated as a foam brush soap. Heavy lather. Easy to rinse. Cherry fragrance. Excellent sudsing action. Biodegradable. Dilute up to 1:150.

Available Size(s): 5, 15, 30, 55 gallons

PCW36 Foamy Lube Detergent

TAS



Concentrate. Unique liquid detergent that combines alkalinity for cleaning and copious foam for visual appeal. Viscous product provides tremendous lubricity and high foam levels. Makes cloth quiet. May be applied through a foamer or directly on cloth or bristle. Biodegradable. Dilute up to 1:640.

Available Size(s): 5, 15, 30, 55 gallons

PCW68 Lemon Foam Brush

S



Concentrate. Formulated for self service car wash applications. This high foaming brush detergent produces a rich, long lasting lather of lubricity which reduces effort in washing and lowers wipe down time. Will work in metering devices and free rinses. Lemon fragrance. Biodegradable. Dilute up to 1:150.

Available Size(s): 5, 15, 30 gallons

PCW101 Blue Citrus Foamy Lube

TAS



Concentrate. First step low pH presoak, ideal for touchless and conveyor car washes. Contains both natural and synthetic cleaners to deliver outstanding performance. Degreasing is achieved with d-limonene, while industrial co-solvents attack additional stubborn soils. High levels of chelating agents give great hard water stability. 100% active surfactants allow for great foam profiles at high dilution rates. Citrus fragrance. Biodegradable. Dilute up to 1:540.

Available Size(s): 5, 15, 30, 55 gallons

PCW69 Tri-Foam Combo Green

TS



Concentrate. Specially formulated as a self-service foam brush soap or for tunnel tri-foam application. Phosphate free. Melon fragrance. Biodegradable. Dilute up to 1:200.

Available Size(s): 5, 15, 30, 55 gallons

PCW38 No Freeze Red

S



Specially formulated anti-freeze foam brush detergent. Formulated with a high concentration of methanol. Biodegradable. Dilute up to 1:5.

Available Size(s): 5 gallons

PCW70 Cherry Blast Car Wash

T



Concentrate. A high foam, economical car wash detergent. Works great as a bucket soap in full service and exterior tunnel washes. Cherry fragrance. Biodegradable. Dilute up to 1:75.

Available Size(s): 5, 15, 30, 55 gallons



Unable to find what you need?
Call our customer service at 1-800-323-3521!



Triple Foam

Polishes and Conditioners (High pH)

PCW1 GOLD Foam Polish

TAS



Concentrate. Formulated to deliver a high gloss, rinse free shine. Vibrant gold color. Biodegradable. Cherry fragrance. Dilute up to 1:300.

Available Size(s): 5, 15, 30 gallons

PCW2 PINK Foam Polish

TAS



Concentrate. Formulated to deliver a high gloss, rinse free shine. Vibrant pink color. Biodegradable. Cherry fragrance. Dilute up to 1:300.

Available Size(s): 5, 15, 30 gallons

PCW3 BLUE Foam Polish

TAS



Concentrate. Formulated to deliver a high gloss, rinse free shine. Vibrant blue color. Biodegradable. Cherry fragrance. Dilute up to 1:300.

Available Size(s): 5, 15, 30 gallons

PCW95 Purple Foam Polish / Conditioner

TAS



Concentrate. Formulated to deliver a high gloss, rinse free shine. Vibrant purple color. Cherry fragrance. Dilute at a ratio of 1:100 up to 1:300.

Available Size(s): 5, 15, 30 gallons

PCW96 Orange Foam Polish / Conditioner

TAS



Concentrate. Formulated to deliver a high gloss, rinse free shine. Vibrant orange color. Cherry fragrance. Dilute at a ratio of 1:100 up to 1:300.

Available Size(s): 5, 15, 30 gallons

PCW97 Green Foam Polish / Conditioner

TAS



Concentrate. Formulated to deliver a high gloss, rinse free shine. Vibrant green color. Cherry fragrance. Dilute at a ratio of 1:100 up to 1:300.

Available Size(s): 5, 15, 30 gallons

PCW20 BLUE Polish II / Conditioner

TAS



Concentrate. Economical. High sudsing foam polish specially formulated for automated car washes. Vibrant color, free-rinsing and excellent shine. Biodegradable. Bubble gum fragrance. Dilute up to 1:100.

Available Size(s): 5, 15, 30 gallons

PCW21 PINK Polish II / Conditioner

TAS



Concentrate. Economical. High sudsing foam polish specially formulated for automated car washes. Vibrant color, free-rinsing and excellent shine. Biodegradable. Bubble gum fragrance. Dilute up to 1:100.

Available Size(s): 5, 15, 30 gallons

PCW22 YELLOW Polish II / Conditioner

TAS



Concentrate. Economical. High sudsing foam polish specially formulated for automated car washes. Vibrant color, free-rinsing and excellent shine. Biodegradable. Bubble gum fragrance. Dilute up to 1:100.

Available Size(s): 5, 15, 30 gallons

PCW84 Foamy Lube GOLD

TAS



Concentrate. A unique liquid detergent that combines alkalinity and water miscible solvents to clean, degrease and generate high foam for visual appeal. It is a viscous product that will provide tremendous lubricity and high foam levels. May be applied through a foamer or directly on to cloth or bristle. Cherry fragrance. Biodegradable. Dilute up to 1:640.

Available Size(s): 5, 15, 30, 55 gallons

PCW85 Foamy Lube RED

TAS



Concentrate. A unique liquid detergent that combines alkalinity and water miscible solvents to clean, degrease and generate high foam for visual appeal. It is a viscous product that will provide tremendous lubricity and high foam levels. May be applied through a foamer or directly on to cloth or bristle. Cherry fragrance. Biodegradable. Dilute up to 1:640.

Available Size(s): 5, 15, 30, 55 gallons

PCW86 Foamy Lube BLUE

TAS



Concentrate. A unique liquid detergent that combines alkalinity and water miscible solvents to clean, degrease and generate high foam for visual appeal. It is a viscous product that will provide tremendous lubricity and high foam levels. May be applied through a foamer or directly on to cloth or bristle. Cherry fragrance. Biodegradable. Dilute up to 1:640.

Available Size(s): 5, 15, 30, 55 gallons

Triple Foam

Polishes and Conditioners (High pH)

Polishes and Conditioners (Low pH)

PCW54 **FASTBREAK Red Triple Foam**

T A



Concentrate. A high sudsing polish and conditioner that produces vibrant color, free rinsing and a glossy shine. Foam breaks to allow quick rinsing in short tunnel applications. Bubble gum fragrance. Biodegradable. Dilute up to 1:200.

Available Size(s): 5, 15, 30, 55 gallons

PCW65 **FASTBREAK BLUE Low pH Triple Foam**

T A S



Concentrate. Deep vibrant color. Good water break and beadability. Works great in touchless In-bay automatics. Leaves vehicle shiny and dry. Works well in hard water conditions. Biodegradable. Bubble gum fragrance. Dilute up to 1:150.

Available Size(s): 5, 15, 30, 55 gallons

PCW55 **FASTBREAK Yellow Triple Foam**

T A



Concentrate. A high sudsing polish and conditioner that produces vibrant color, free rinsing and a glossy shine. Foam breaks to allow quick rinsing in short tunnel applications. Bubble gum fragrance. Biodegradable. Dilute up to 1:200.

Available Size(s): 5, 15, 30, 55 gallons

PCW66 **FASTBREAK RED Low pH Triple Foam**

T A S



Concentrate. Deep vibrant color. Good water break and beadability. Works great in touchless In-bay automatics. Leaves vehicle shiny and dry. Works well in hard water conditions. Biodegradable. Bubble gum fragrance. Dilute up to 1:150.

Available Size(s): 5, 15, 30, 55 gallons

PCW56 **FASTBREAK Blue Triple Foam**

T A



Concentrate. A high sudsing polish and conditioner that produces vibrant color, free rinsing and a glossy shine. Foam breaks to allow quick rinsing in short tunnel applications. Bubble gum fragrance. Biodegradable. Dilute up to 1:200.

Available Size(s): 5, 15, 30, 55 gallons

PCW67 **FASTBREAK YELLOW Low pH Triple Foam**

T A S



Concentrate. Deep vibrant color. Good water break and beadability. Works great in touchless In-bay automatics. Leaves vehicle shiny and dry. Works well in hard water conditions. Biodegradable. Bubble gum fragrance. Dilute up to 1:150.

Available Size(s): 5, 15, 30, 55 gallons

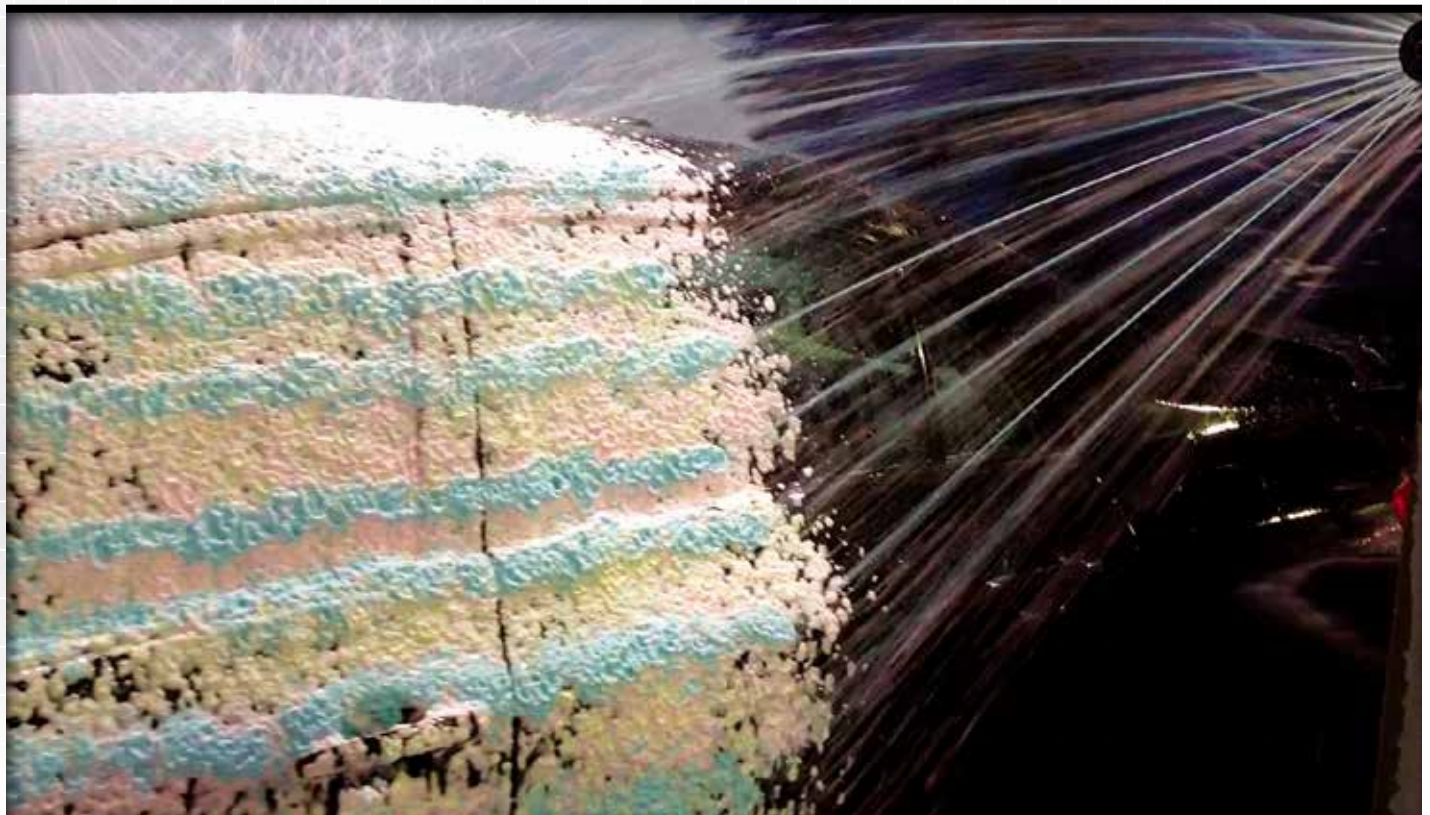

Rinse Agents

Protectants

PCW9 Super Beads Drying Agent

T A



Concentrate. Highly concentrated drying agent and rinse aid for automatic car wash applications. Added to final rinse water cycle, promotes water beading; easier blow-off, leaving a spot-free surface. Excellent non-streaking, non-spotting formula. Biodegradable. Dilute up to 1:400 for rinse cycle.

Available Size(s): 5, 15, 30, 55 gallons

PCW4 PLATINUM TVP - Original

T A S



Concentrate. A new generation Total Vehicle Protection concentrate designed to promote water beading, detergent resistance, UV protection, gloss and sheeting action to the total vehicle. Excellent in touchless and in-bay automatic car wash systems. Can also be used in a bubbler or lava arch. Biodegradable. Banana fragrance. Dilute up to 1:300.

Available Size(s): 5, 15, 30, 55 gallons

PCW13 Cherry Drying Agent

T A S



Concentrate. Economical rinse aid for tunnel wash applications. Great spray wax for self-serve, rollovers and automatic car washes. Non-streaking; makes easy water blow-off. Cherry fragrance. Biodegradable. Dilute up to 1:200.

Available Size(s): 5, 15, 30, 55 gallons

PCW47 PLATINUM TVP - BLUE

T A



Concentrate. Our premium Total Vehicle Protection surface reacting, foaming clearcoat is formulated to promote water beading, detergent resistance, UV protection, gloss and sheeting action to the total vehicle while providing a brilliant visual show. Biodegradable. Pleasant fragrance. Dilute up to 1:400.

Available Size(s): 5, 15, 30, 55 gallons

PCW34 Sahara Drying Agent

T A S



Concentrate. High quality combination drying agent and sealer. This product provides both beading and sheen. Especially effective in touchless washes as well as high speed conveyors and in-bay automatics. Biodegradable. Mulberry fragrance. Dilute up to 1:200.

Available Size(s): 5, 15, 55 gallons

PCW88 Triple Shine TVP

T A S



Concentrate. The ideal choice for surface protection. Formulated to bolster shine, water repellency and durability to the entire surface of the vehicle. Protects against harmful UV rays. Delivers outstanding performance in touchless tunnel and in bay automatic vehicle wash systems. Grape fragrance. Biodegradable. Dilute up to 1:300.

Available Size(s): 5, 15, 30, 55 gallons

PCW62 Vivid Dry

T A



Concentrate. Our finest, most concentrated drying agent and rinse aid. Contains the maximum water breaking technology in the industry. Imparts vehicles with a great shine! Biodegradable. Dilute up to 1:600.

Available Size(s): 5, 15, 30, 55 gallons

PCW5 Invision Protectant

T A



Concentrate. Excellent non-streaking, economical, clear coat protectant for painted surfaces. Promotes water beading. Prevents water spotting. Great shine. Use in automatic and coin operated car washes. Biodegradable. Mulberry fragrance. Dilute up to 1:200.

Available Size(s): 5, 15, 30 gallons

When you order Platinum, you get the best value for your operation. Platinum Professional Car Wash products are packaged in 5's, 15's, 30's, and 55's.

5's to 55's - Pick the sizes that meet your needs and order today!

To Order Call: 1.800.323.3521

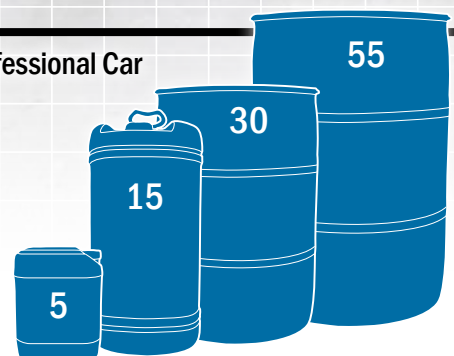

On-Line Waxes

PCW98 Lava Wax Orange

T A



Utilizes modern, surface enhancing chemistry including micro-ionized carnauba wax. This formula will provide UV protection, impart gloss, enhance water beading & shedding and reduce spotting - increasing the shine and protection on every vehicle washed. Bubble gum fragrance. Dilute up to 1:300.

Available Size(s): 5, 15, 30 gallons



PCW99 Lava Wax Cherry

T A



Utilizes modern, surface enhancing chemistry including micro-ionized carnauba wax. This formula will provide UV protection, impart gloss, enhance water beading & shedding and reduce spotting - increasing the shine and protection on every vehicle washed. Cherry fragrance. Dilute up to 1:300.

Available Size(s): 5, 15, 30 gallons



PCW100 Lava Wax Grape

T A



Utilizes modern, surface enhancing chemistry including micro-ionized carnauba wax. This formula will provide UV protection, impart gloss, enhance water beading & shedding and reduce spotting - increasing the shine and protection on every vehicle washed. Grape fragrance. Dilute up to 1:300.

Available Size(s): 5, 15, 30 gallons



LAVA WAX
 Protect & Shine Every Time
 Fortified with Carnauba Wax!



Lava Wax signage now available!
 See page 126-130



Ceramic Protectant

Ceramic Fortified Protection

T A

PCW102 **PLATINUM CERAMIC SHIELD®**



Platinum Ceramic Shield® is the first ceramic fortified type of product developed exclusively for automatic car washes. This industry breakthrough product allows consumers to have whole vehicle ceramic protection from the ease of use of the drive through wash. The ceramic material forms a chemical bond to all exterior surfaces and creates a wear resistant coating. The treated surfaces will have increased gloss and shine along with great water beading. A touch of slickness is added to the painted surfaces to reduce the buildup of dirt, grime, bugs, and industrial fallout. Fine spray nozzles from the arch allows the product to penetrate the hardest to reach areas, including moldings, emblems, cracks and crevices.

Available Size(s): 5, 15, 30 gallons



PLATINUM CERAMIC SHIELD® APPLICATION ARCH

Construction:	Anodized aluminum structure with aluminum composite graphic panels.
Dimensions:	Exterior - 136" (max) h x 152" w Interior (clearance) - 92.5" (std) h x 112" w
Voltage/Amperage:	100~240VAC / 1.2 AMP (when LED pucks are used)
Illumination:	Spinning LED Puck lights - amber, blue & white OPTIONAL - 144 watt - 6ft color changing LED light bar
Mounting:	Plate is 11.75" x 7"
Available Size(s):	Each

Platinum Ceramic Shield® signage now available!
See page our signage section pages 126-130!

Tire Dressings

On-line and Water Based



PCW63 Pad Master On-Line Dressing

T A



Premium high solids, solvent based, tire dressing designed to work in all types of on-line application systems. Engineered to promote longer life in application pads due to its superior wetting characteristics. Complete coverage; highest shine available.

Available Size(s): 5, 15, 30, 55 gallons

PCW64 H2O Pad Master On-Line Dressing

T A



Water-based, silicone blend tire dressing. Outstanding shine and durability. Designed for application with on-line tire equipment. Will not sling. Complete coverage; high shine. 2 oz. or less, per application.

Available Size(s): 5, 15, 30, 55 gallons

PCW71 Strawberry Sheen Dressing

T A



Water-based tire dressing. A thick water-based formula designed to give a great shine with just a wipe. Excellent durability. Perfect for car washes looking for no sling. Strawberry fragrance.

Available Size(s): 5, 15, 30, 55 gallons

PCW72 Triple-D Dressing

T A S



Water based tire dressing with a blend of silicone oils, emulsions and leveling agents. Designed to give outstanding shine and durability. Complete coverage; high shine. Does not sling.

Dilutions: Exterior surfaces Ready To Use.

Interior surfaces up to 1:4.

Available Size(s): 5, 15, 30, 55 gallons

PCW74 White Cherry Dressing

T A S



Concentrate. A blend of fine particle size high and low molecular weight silicone emulsions for unsurpassed gloss; exterior and interior use. Renews tires, bumpers, weather-stripping, rubber, mats, engines and more. Cherry fragrance. Dilute up to 1:4 for interior surfaces.

Available Size(s): (4) 1gal, 5, 15, 30, 55 gallons

Specialty Products

PCW6 Clear Vision Rain Repellent



Improves all-weather visibility, safety and driving comfort. Easier to remove frost, ice, salt, mud and bugs when applied to exterior glass. Biodegradable.

Available Size(s): 6-16 oz., 5 gallons

PCW60 Leather Conditioner Interior Dressing



A lanolin based interior creme designed to enrich and renew high quality automotive leather upholstery. Provides outstanding shine and gloss with excellent lubricity and water resistance. Pleasant leather fragrance. Solvent free. Biodegradable.

Available Size(s): 6-16 oz., 4-1 gallons

PCW12 Bug-A-Boo

TAS



Concentrate. Safe for removing bugs. Works well in hard water. Phosphate free. Biodegradable. Berry fragrance. Dilute up to 1:15.

Available Size(s): 5, 15, 30, 55 gallons

PCW61 Zapper Bug Remover

TAS



Concentrate. Zapper bug remover is an aggressive formula designed to remove all types of bug residue. Perfect choice for all on-line uses and can be used with a thumb gun or pump style sprayer. Biodegradable. Ideal for "Love Bug" removal. Citrus fragrance. Dilute up to 1:100.

Available Size(s): 5, 15, 30, 55 gallons

PCW42 Premier Tunnel & Equipment Cleaner



Concentrate. Heavy duty non-hydrofluoric acid detergent designed to remove wax scum buildup on walls, equipment and windows. PCW42 will clean and brighten most of these surfaces. Biodegradable. Dilute up to 1:6.

Available Size(s): 5, 15, 30, 55 gallons

PCW75 Liquid Laundry Detergent



An economical, phosphate free detergent brightening agents. Pre-treat set-in and stubborn stains by pouring PCW75 directly on the stain and rub in. Phosphate free. Biodegradable. Fresh fragrance.

Available Size(s): 5, 55 gallons

PCW57 Rust Inhibitor

TAS



Concentrate. PCW57 is a mixture of carboxylic acid salt and other preventatives to inhibit corrosion when used at recommended concentrations. Applied to under carriage of vehicle. Biodegradable. Dilute up to 1:100.

Available Size(s): 5, 15, 30, 55 gallons

PCW76 Sprayable Paint Protection



A sprayable blend of detergent resistant silicones, abrasives, emulsifiers and rheology modifiers. Excellent gloss and lubricity. Biodegradable.

Available Size(s): 4-1 gallons



Fragrance Boosters



Item	Description	Sizes
	Fragrance Boosters Concentrate. Formulated to enhance the car wash experience of the end user during the vehicle washing cycle. Biodegradable. Recommended starting dilution 1:128. 	5 gal/HP TAS
PCW302	Lemon Fragrance	
PCW303	Spearmint Fragrance	
PCW305	Grape Fragrance	
PCW306	Watermelon Fragrance	
PCW307	Cherry Fragrance	
PCW308	Cool Breezzz Fragrance	
PCW309	Fresh Air Fragrance	
The "Booster" fragrances are used with the initial products we provide for the car wash tunnels (full serve & express), in-bay auto-matics, rollovers and self serve. We are now able to increase the fragrance level of any product to enhance the customer appeal when purchasing a wash or wash package.		



Equipment



These car wash series Dosatron's® are perfect for presoaks, detergents and acidic products. Consistency is key and the Dosatron® will provide accurate dilution point and a consistent dilution for a better cost per car. Don't forget the Water Pressure Regulator (PCWPR34) to set lowest water pressure for pump consistency. All Dosatron® units include: mounting bracket, suction hose, weighted strainer & manual.

PCWD14MZ2 **Dosatron® D14MZ2**



Dilution Range: 1:500 to 1:50 (0.2% to 2%)
Water Flow Range: 0.05 to 14 GPM
Operating Pressure Range: 4.3 to 85 PSI
Available Housing Materials: Polypropylene (Standard Blue)
Dimensions: 19 1/18" x 6 5/16"
Weight: 6 lbs
Connection Size: 3/4" NPT
Maximum Temperature: 104° F
Included Accessories: 6' clear suction tube, strainer, weight, mounting bracket and operating manual
Recommended Accessories: PCWPR34 pressure regulator, 200 mesh filter, check valve

Available Size(s): [Each](#)

PCWD14MZ5 **Dosatron® D14MZ5**



Dilution Range: 1:200 to 1:20 (.5% to 5%)
Water Flow Range: 0.05 to 14 GPM
Operating Pressure Range: 4.3 to 85 PSI
Available Housing Materials: Polypropylene (Standard Blue)
Other Options: Viscous
Dimensions: 19 1/18" x 6 5/16"
Weight: 6 lbs
Connection Size: 3/4" NPT
Maximum Temperature: 104° F
Included Accessories: 6' clear suction tube, strainer, weight, mounting bracket and operating manual
Recommended Accessories: PCWPR34 pressure regulator, 200 mesh filter, check valve

Available Size(s): [Each](#)

PCWD25RE1500 **Dosatron® D25RE1500**



Dilution Range: 1:1500 to 1:500 (.07% to .2%)
Water Flow Range: .05 to 11 GPM
Operating Pressure Range: 4.3 to 85 PSI
Available Housing Materials: Polyacetal (Standard Blue)
Dimensions: 14" x 6 1/4"
Weight: 4 lbs
Connection Size: 3/4" NPT
Maximum Temperature: 104° F
Included Accessories: 6 ft clear suction tube, strainer, weight, mounting bracket and operating manual
Recommended Accessories: PCWPR34 pressure regulator, 200 mesh filter, check valve

Available Size(s): [Each](#)

PCWPR34 **Water Pressure Regulator**



Use with PCWD14MZ2, PCWD14MZ5 & PCWD25RE1500 to set lowest water pressure for pump consistency. 3/4" NPT chrome plated brass body with 2" face.

Female inlet and outlet
Working pressure: 15-87 psi
Max incoming pressure: 230 psi
Max Temperature: 140° F
Preset at 43.5 psi

Available Size(s): [Each](#)

ECP2201 **1-Port Proportioner**



Wall mount, 1-port proportioner is ideal for car wash. (4) gallons per minute.

Available Size(s): [Each](#)

ECP2202 **1-Port Drum Mount Proportioner**



Mounts directly to drum with single port. Ideal for car washes & APC.

Available Size(s): [Each](#)

ECP2203 **3-Port Proportioner**



Wall mount 3-port proportioner.

Available Size(s): [Each](#)

See pages 130-131 for Tables & Charts

Equipment

PCW514

Titration Kit



Kit containing titration procedures for testing specific ECP Inc. alkaline and acid automotive washes and cleaners.

KIT CONTENTS:

- | | |
|------------------------------------|---|
| 1 - 500 mL Hydrochloric Acid 0.1 N | 1 - 25 mL Glass Sample Cell |
| 1 - 500 mL Hydrochloric Acid 0.6 N | 1 - 16 oz. Glass Container |
| 1 - 500 mL Hydrochloric Acid 1.0 N | 5 - Plastic Dropper Squeezable Transfer Bottles |
| 1 - 500 mL Sodium Hydroxide 1.0 N | 10 - 3 mL Graduated Plastic Transfer Pipettes |
| 2 - 125 mL Indicator Solution | 1 - pH+ Pocket Meter |
| | 1 - Pair of Safety Glasses |
| | 10 - Pairs of Black Nitrile Gloves |

Available Size(s): Each



PCW675 100 mL Graduated Cylinder

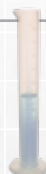

Polypropylene 100 mL graduated cylinder. Single metric scale with raised numerals in 1 mL graduation. Chemical resistant.

Available Size(s): Each

PCW676 250 mL Graduated Cylinder



Polypropylene 250 mL graduated cylinder. Single metric scale with raised numerals in 2 mL graduation. Chemical resistant.

Available Size(s): Each

PCW677 500 mL Graduated Cylinder













Polypropylene 500 mL graduated cylinder. Single metric scale with raised numerals in 5 mL graduation. Chemical resistant.

Available Size(s): Each

Banners

Vinyl - Full Color Graphics

Item	Description	Sizes
 PCW540	Banner Tri Foam. Vinyl full color graphic banner with four corner grommets.	96" w x 30" h
 PCW541	Banner Clear Coat Protectant. Vinyl full color graphic banner with four corner grommets.	96" w x 30" h
 PCW542	Banner Take Your Vehicle Platinum. Vinyl full color graphic banner with four corner grommets.	96" w x 30" h
 PCW543	Banner Tire Shine. Vinyl full color graphic banner with four corner grommets. Features text "Add it to any wash for just \$2".	96" w x 30" h
 PCW544	Banner Total Vehicle Protection. Vinyl full color graphic banner with four corner grommets.	96" w x 30" h
 PCW545	Banner Car Wash Open. Vinyl full color graphic banner with four corner grommets.	96" w x 30" h
 PCW546	Banner Platinum Professional Products. Vinyl full color graphic banner with four corner grommets.	96" w x 30" h
 PCW547	Banner Tire Shine. Vinyl full color graphic banner with four corner grommets.	96" w x 30" h
 PCW548	Banner Lava Wax. Vinyl full color graphic banner with four corner grommets.	96" w x 30" h
 PCW549	Banner Platinum Ceramic Shield®. Vinyl full color graphic banner with four corner grommets.	96" w x 30" h



Not seeing what you are looking for?

CUSTOM SIGNAGE

Windmasters & Frames

Full Color Graphics - Standard & Mini Windmasters

Inserts



Item	Description	Sizes
PCW560	Frame Standard Windmaster Frame w/Stand *Standard Windmaster frames require (2) inserts.	28" w x 44" h
PCW561	Insert / Windmaster Tri-Foam insert.	28" w x 44" h
PCW562	Insert / Windmaster Clear Coat Protectant insert.	28" w x 44" h
PCW563	Insert / Windmaster Take Your Vehicle Platinum insert.	28" w x 44" h
PCW564	Insert / Windmaster Tire Shine insert - \$2 option.	28" w x 44" h
PCW565	Insert / Windmaster Total Vehicle Protection insert.	28" w x 44" h
PCW566	Insert / Windmaster Car Wash Open insert.	28" w x 44" h
PCW567	Insert / Windmaster Platinum Professional Products insert.	28" w x 44" h
PCW568	Insert / Windmaster Tire Shine insert.	28" w x 44" h
PCW569	Insert / Windmaster Lava Wax - Orange insert.	28" w x 44" h
PCW570	Insert / Windmaster Lava Wax - Cherry insert.	28" w x 44" h
PCW571	Insert / Windmaster Lava Wax - Grape insert.	28" w x 44" h
PCW572	Insert / Windmaster Platinum Ceramic Shield™ insert.	28" w x 44" h
PCW580	Frame Mini Windmaster Frame w/wheels *Mini Windmaster frames require (2) inserts.	22" w x 28" h
PCW581	Insert / Windmaster Tri-Foam insert.	22" w x 28" h
PCW582	Insert / Windmaster Clear Coat Protectant insert.	22" w x 28" h
PCW583	Insert / Windmaster Take Your Vehicle Platinum insert.	22" w x 28" h
PCW584	Insert / Windmaster Tire Shine insert - \$2 option.	22" w x 28" h
PCW585	Insert / Windmaster Total Vehicle Protection insert.	22" w x 28" h
PCW586	Insert / Windmaster Car Wash Open insert.	22" w x 28" h
PCW587	Insert / Windmaster Platinum Professional Products insert.	22" w x 28" h
PCW588	Insert / Windmaster Tire Shine insert.	22" w x 28" h



Windmasters & Frames

Full Color Graphics - Curb Sign and Antenna Windmasters

Inserts



Item	Description	Sizes
	Curb Sign Double Sided Curb Sign. *Curb Sign comes complete with frame and 2-sided Aluminum Insert.	24" w x 36" h
PCW600	Curb Sign Tri-Foam insert.	24" w x 36" h
PCW601	Curb Sign Clear Coat Protectant insert.	24" w x 36" h
PCW602	Curb Sign Take Your Vehicle Platinum insert.	24" w x 36" h
PCW603	Curb Sign Tire Shine insert - \$2 option.	24" w x 36" h
PCW604	Curb Sign Total Vehicle Protection insert.	24" w x 36" h
PCW605	Curb Sign Car Wash Open insert.	24" w x 36" h
PCW606	Curb Sign Platinum Professional Products insert.	24" w x 36" h
PCW607	Curb Sign Tire Shine insert.	24" w x 36" h
PCW620	Frame Antenna Windmaster Frame *Antenna Windmaster frame is designed for single sided inserts.	36" w x 60" h
PCW621	Antenna / Windmaster Tri-Foam insert.	36" w x 60" h
PCW622	Antenna / Windmaster Clear Coat Protectant insert.	36" w x 60" h
PCW623	Antenna / Windmaster Take Your Vehicle Platinum insert.	36" w x 60" h
PCW624	Antenna / Windmaster Tire Shine insert - \$2 option.	36" w x 60" h
PCW625	Antenna / Windmaster Total Vehicle Protection insert.	36" w x 60" h
PCW626	Antenna / Windmaster Car Wash Open insert.	36" w x 60" h
PCW627	Antenna / Windmaster Platinum Professional Products insert.	36" w x 60" h
PCW628	Antenna / Windmaster Tire Shine insert.	36" w x 60" h



Not seeing what you are looking for?

ASK ABOUT OUR
CUSTOM SIGNAGE!

Cone Toppers & Drum Covers

Full Color Graphics

Cone Toppers



Item	Description	Sizes
PCW519	Traffic Cone 28" Flexible Traffic Cone *Heavy duty flexible vinyl traffic cones. Not harmful to vehicles. Comes with Platinum Logo.	28" tall
PCW520	Cone Topper Tri-Foam insert.	28" w x 44" h
PCW521	Cone Topper Clear Coat Protectant insert.	28" w x 44" h
PCW522	Cone Topper Take Your Vehicle Platinum insert.	28" w x 44" h
PCW523	Cone Topper Tire Shine insert.	28" w x 44" h
PCW524	Cone Topper Total Vehicle Protection insert.	28" w x 44" h
PCW525	Cone Topper Car Wash Open insert.	28" w x 44" h
PCW526	Cone Topper Platinum Professional Products insert.	28" w x 44" h
PCW527	Cone Topper Platinum Ceramic Shield® insert.	28" w x 44" h

Drum Covers



Item	Description	Sizes
	Drum Cover 55 Gallon Drum Cover Heavy duty all weather vinyl 55 gallon drum cover.	55 gal
PCW640	Drum Cover Tri-Foam	55 gal
PCW641	Drum Cover Clear Coat Protectant	55 gal
PCW642	Drum Cover Take Your Vehicle Platinum	55 gal
PCW643	Drum Cover Tire Shine	55 gal
PCW644	Drum Cover Total Vehicle Protection	55 gal
PCW645	Drum Cover Car Wash Open	55 gal
PCW646	Drum Cover Platinum Professional Products	55 gal
PCW647	Drum Cover Platinum Ceramic Shield®	55 gal

Tables & Charts

HYDROMINDER TIP CHART

		MODEL NUMBER							
		506	511	515	525	530	532	560/565	546/551
Flow Rate →		4.5 GPM	4.5 GPM	1.5 GPM	9 GPM	9 GPM	6 GPM	25 GPM	18 GPM
Tip (color)	No Tip	1:4	1:4	1:1	1:4	1:4	1:3	1:10	1:6.5
	Gray	1:5	1:5	1:1.2	1:6	1:6	1:4	1:20	1:12
	Black	1:6	1:6	1:2	1:10	1:10	1:5	1:30	1:20
	Beige	1:8	1:8	1:4	1:20	1:20	1:7	1:64	1:38
	Red	1:17	1:17	1:6	1:35	1:35	1:12	1:128	1:68
	White	1:23	1:23	1:9	1:52	1:52	1:17	1:144	1:95
	Blue	1:25	1:25	1:10	1:55	1:55	1:18	1:173	1:105
	Tan	1:36	1:36	1:13	1:70	1:70	1:24	1:218	1:130
	Green	1:48	1:48	1:21	1:100	1:100	1:35	1:306	1:180
	Orange	1:64	1:64	1:26	1:140	1:140	1:46	1:424	1:270
	Brown	1:75	1:75	1:30	1:160	1:160	1:52	1:768	1:310
	Yellow	1:90	1:90	1:38	1:190	1:190	1:62	1:896	1:380
	Purple	1:120	1:120	1:50	1:250	1:250	1:75	1:930	1:610
	Pink	1:240	1:240	1:100	1:530	1:530	1:195	1:1024	1:1200

NOTE: Dilution ratios given above are based on 40 psi of water and water thin viscosity (1 CPS)

Directions and Dilutions for Hydrominder Ultra Lean Tip Kit

DIRECTIONS:

1. Replace existing hose barb on Hydrominder with 1/4" hose barb. This will hold the Ultra Lean tips.
2. Determine the appropriate dilution according to product and insert the small end of the colored tip into the hose barb.
3. Slide the tubing over the tip and hose barb.
4. Insert foot valve into the other end of tubing and insert into Prime Pak box. A ceramic weight should be used for weighing.

If drawing the product through the tube becomes difficult, add a 6" to 8" piece of 3/8" tubing to the bottom of the 1/4" draw tube and remove fine screen from foot valve.

FOR 511 HYDROMINDER 4GPM

PART#	COLOR	SIZE	DILUTION
10027000	Pink	.010	1:355
10027001	Lt. Purple	.009	1:465
10027002	Olive Green	.008	1:530
10027003	Red Purple	.007	1:880
10027004	Lt. Orange	.006	1:1030

Platinum Tech Tip:

Using the proper nozzle can reduce water consumption and maintain a better rinse.



Nozzle Chart For Rinse Arches

		VOLUME (GPM At Various Pressure [PSI])							
NOZZLE SIZE	ORIFICE DIM. (IN.)	40 PSI	100 PSI	250 PSI	500 PSI	700 PSI	800 PSI	1000 PSI	
.050	.018	.050	.080	.120	.180	.200	.225	.250	
.067	.021	.067	.110	.160	.240	.280	.300	.330	
1.00	.026	.100	.160	.250	.350	.400	.425	.500	
2.00	.034	.200	.320	.500	.710	.800	.890	1.00	
3.00	.043	.300	.470	.750	1.10	1.25	1.35	1.50	
4.00	.052	.400	.630	1.00	1.40	1.70	1.80	2.00	
5.00	.057	.500	.790	1.30	1.80	2.10	2.20	2.50	
6.00	.062	.600	.950	1.50	2.10	2.50	2.70	3.00	
8.00	.072	.800	1.30	2.00	2.80	3.40	3.60	4.00	
10.0	.080	1.00	1.60	2.50	3.50	4.20	4.50	5.00	
15.0	.094	1.50	2.40	3.80	5.30	6.40	6.80	7.50	
20.0	.109	2.00	3.20	5.00	7.10	8.40	9.00	10.0	
40.0	.156	4.00	6.30	10.0	14.2	16.8	18.0	20.0	

Nozzle Coverage Chart at 12"



CHEM-FLEX™ INJECTORS CHEMICAL DILUTION RATIOS

(Assumes feed pressure of 200 PSI (14 bar))

		#8-32 METERING TIPS									
Flow Rate (GPM) at 200 PSI		0.25	0.50	0.75	1.00	1.50	2.00	2.25	3.25	4.50	5.50
Injector Color →		White	Yellow	Tan	Red	Orange	Gray	Blue	Light Green	Purple	Dark Green
Nozzle Size →		0.029" (0.7 mm)	0.040" (1.0 mm)	0.051" (1.3 mm)	0.057" (1.4 mm)	0.070" (1.8 mm)	0.083" (2.1 mm)	0.086" (2.2 mm)	0.098" (2.5 mm)	0.117" (2.9 mm)	0.125" (3.2 mm)
Metering Tip	COPPER	1: 57	1: 104	1: 155	1: 195	1: 281	1: 406	1: 468	1: 629	1: 881	1: 1074
	PUMPKIN	1: 43	1: 82	1: 119	1: 126	1: 238	1: 348	1: 398	1: 554	1: 774	1: 946
	BURGUNDY	1: 34	1: 67	1: 97	1: 111	1: 207	1: 304	1: 347	1: 495	1: 690	1: 845
	LIME	1: 28	1: 57	1: 81	1: 100	1: 183	1: 270	1: 307	1: 447	1: 622	1: 764
	TAN	1: 28	1: 57	1: 81	1: 100	1: 183	1: 270	1: 307	1: 447	1: 622	1: 764
	ORANGE	1: 23	1: 44	1: 64	1: 78	1: 137	1: 196	1: 215	1: 314	1: 437	1: 536
	TURQUOISE	1: 17	1: 31	1: 45	1: 55	1: 91	1: 126	1: 134	1: 197	1: 274	1: 336
	PINK	1: 14	1: 24	1: 35	1: 42	1: 68	1: 93	1: 98	1: 143	1: 188	1: 224
	LIGHT BLUE	1: 11	1: 17	1: 24	1: 31	1: 47	1: 64	1: 66	1: 98	1: 136	1: 166
	BROWN	1: 10	1: 15	1: 22	1: 28	1: 43	1: 58	1: 59	1: 88	1: 122	1: 150
	RED		1: 12	1: 17	1: 23	1: 34	1: 45	1: 46	1: 69	1: 95	1: 116
	WHITE		1: 12	1: 16	1: 22	1: 31	1: 42	1: 43	1: 64	1: 88	1: 108
	GREEN		1: 11	1: 14	1: 20	1: 28	1: 37	1: 38	1: 55	1: 76	1: 94
	BLUE		1: 10	1: 12	1: 17	1: 23	1: 30	1: 31	1: 46	1: 63	1: 77
	YELLOW			1: 9	1: 12	1: 16	1: 20	1: 22	1: 31	1: 42	1: 52
	BLACK				1: 10	1: 13	1: 16	1: 17	1: 24	1: 33	1: 40
	PURPLE				1: 6.6	1: 8.3	1: 9	1: 10	1: 13	1: 17	1: 21
GRAY				1: 5.3	1: 6.7	1: 6.9	1: 7.6	1: 10	1: 13	1: 16	
OPEN				1: 4.9	1: 5.3	1: 5.2	1: 6.0	1: 6.1	1: 8.3	1: 10	

		SPIRAL METERING PLUGS*									
Flow Rate (GPM) at 200 PSI		0.25	0.50	0.75	1.00	1.50	2.00	2.25	3.25	4.50	5.50
Injector Color →		White	Yellow	Tan	Red	Orange	Gray	Blue	Light Green	Purple	Dark Green
Nozzle Size →		0.029" (0.7 mm)	0.040" (1.0 mm)	0.051" (1.3 mm)	0.057" (1.4 mm)	0.070" (1.8 mm)	0.083" (2.1 mm)	0.086" (2.2 mm)	0.098" (2.5 mm)	0.117" (2.9 mm)	0.125" (3.2 mm)
Spiral Plug Length	3.00"	1: 251	1: 503	1: 754	1: 1006	1: 1509	1: 2012	1: 2263	1: 3269	1: 4526	1: 5532
	2.00"	1: 181	1: 363	1: 544	1: 726	1: 1089	1: 1451	1: 1633	1: 2359	1: 3266	1: 3991
	1.00"	1: 104	1: 208	1: 311	1: 415	1: 623	1: 831	1: 934	1: 1350	1: 1869	1: 2284
	0.75"	1: 82	1: 165	1: 247	1: 329	1: 494	1: 659	1: 741	1: 1071	1: 1483	1: 1812
	0.50"	1: 59	1: 119	1: 178	1: 238	1: 357	1: 475	1: 535	1: 772	1: 1069	1: 1307
	0.25"	1: 34	1: 68	1: 102	1: 136	1: 204	1: 272	1: 306	1: 442	1: 612	1: 748

NOTE: Dilution ratios given above are based on drawing water through the metering tips and are meant as a starting point for system configuration. Results are expected to vary when drawing chemicals due to differences in viscosity and temperature.

GHS/HMIS SAFETY LABELS

With ECP you get the latest GHS/HMIS compliant safety labels now!

To order or for more information, speak with your Technician's Choice representative today!

For our Canadian distributors, our labels are also WHMIS compliant!

"Existing fines and penalties for non-compliance with HCS and WHMIS extend to GHS alignment with these same standards. In the United States, that means that HCS violations, which already rank #3 on OSHA's Top Ten Violations List, could see even more action. And WHMIS penalties of up to \$1 million in fines and two years in prison will remain a serious consideration for anyone with obligations under Canada's hazard communication standard." - www.msdsolnline.com/



Tomorrow's Technology Today

TECHNICIAN'S CHOICE
PROFESSIONAL SERIES

**TEC487
FIRE WATER
MULTI-PURPOSE
CLEANER**
NETTOYANT TOUT USAGE

HAZARD:

Harmful if swallowed or in contact with skin. Causes severe skin burns and eye damage. May cause damage to liver, kidneys or blood through prolonged or repeated exposure.

Nocif en cas d'ingestion ou de contact cutané. Provoque des brûlures de la peau et des lésions oculaires graves. Risque pressenti d'effets graves pour les organes à la suite d'expositions répétées ou d'une exposition prolongée.

KEEP OUT OF REACH OF CHILDREN
FOR PROFESSIONAL USE ONLY
REFER TO SDS BEFORE USE
USE IN A WELL VENTILATED AREA
ALWAYS WEAR RECOMMENDED SAFETY EQUIPMENT.

THIS CONTAINER NOT FILLED UNDER CONTROL OF ECP

PRECAUTIONARY STATEMENTS: If medical advice is needed, have product container or label at hand; Keep out of reach of children; Read label before use; Do not handle until all safety precautions have been read and understood; Avoid breathing fumes, mist, vapors & spray; Wash hands thoroughly after handling; Wear protective gloves, protective clothing, eye protection & face protection; IF IN EYES: Rinse cautiously with water for several minutes; Remove contact lenses, if present and easy to do; Continue rinsing; IF ON CLOTHING: Rinse immediately contaminated clothing and skin with plenty of water before removing clothes; If skin irritation or rash occurs; Get medical advice/attention; If eye irritation persists; Get medical advice/attention; If experiencing respiratory symptoms; Call a POISON CENTER doctor; Take off immediately all contaminated clothing and wash it before reuse.

CONSEILS DE PRUDENCE: En cas de consultation d'un médecin, garder à disposition le récipient ou l'étiquette; Tenir hors de portée des enfants; Lire l'étiquette avant utilisation; Ne pas manipuler avant d'avoir lu et compris toutes les précautions de sécurité; Laver soigneusement les mains après avoir manipulé; Porter des gants de protection/des vêtements de protection/un équipement de protection des yeux/du visage; EN CAS DE CONTACT AVEC LES YEUX: rincer avec précaution à l'eau pendant plusieurs minutes; Enlever les lentilles de contact si la victime en porte et si elles peuvent être facilement enlevées; Continuer à rincer; EN CAS DE CONTACT AVEC LES VÊTEMENTS: rincer immédiatement et abondamment avec de l'eau les vêtements contaminés et le peau avant de les enlever; En cas d'irritation ou d'urgence cutanée; consulter un médecin; Si l'irritation oculaire persiste; consulter un médecin; En cas de symptômes respiratoires; appeler un CENTRE ANTIPOISON ou un médecin; Enlever immédiatement tout vêtement souillé tout et laver avant de les réutiliser.

INGREDIENTS: Water (CAS 7732-18-5); 2-Alkylthiazolid (CAS 111-76-2); Alkyl Polyglycoside (CAS 98515-73-1); Potassium Hydroxide (CAS 1310-58-3); Alkyl Imino Acid, Sodium Salt (CAS 64972-19-6).

Manufactured by
ECP Incorporated
11210 Katherine's King
Suite 100
Woodridge, IL 60517
1-800-323-3521
www.ecplinc.net

HMIS Rating:	HEALTH	3
4 = Severe	FLAMMABILITY	0
3 = Serious	REACTIVITY	0
2 = Moderate	PERSONAL PROTECTION	C
1 = Slight		
0 = Minimal		

Technician's Choice® is a registered trademark of ECP Inc. ©2015

4" X 6" FULL COLOR SAFETY LABEL

Get compliant. Ask for safety/transfer labels with your order today!
Call our customer service team at 1-800-323-3521

Refer to SDS before use

Pallet Configurations

SIZE	QUANTITY / PALLET
275 Gallon Tote	1
55 Gallon Drum	4
30 Gallon Drum	5
15 Gallon Keg	9
5 Gallon Plastic Head Pack	48
5 Gallon Metal Pail	36
4 - 1 Gallon / Case	36
12 Quarts / Case	50
6 Pints / Case	100
300 lb. Fiber Drum	4
100 lb. Fiber Drum	18
50 lb. Fiber Drum	18
35 lb. Fiber Drum	36

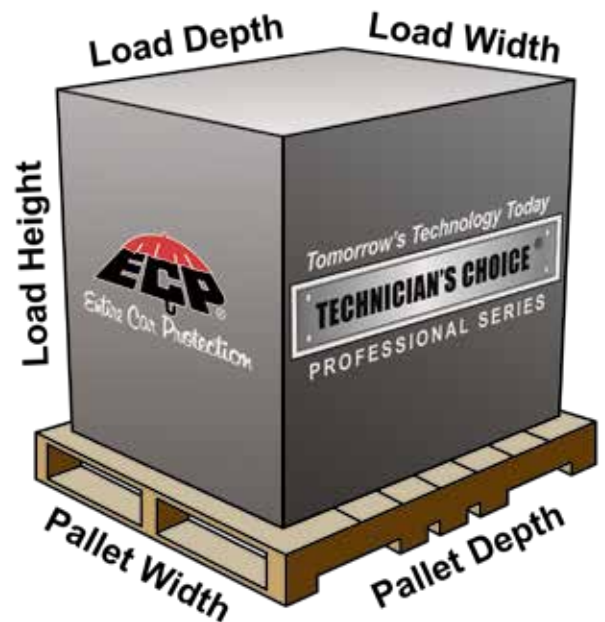

Always wear recommended safety equipment

S-100C Tornador® Cordless HVLP Spray Gun	59	TEC1207 Microfiber Towel - Yellow	107	TEC1356 Center Pull Towel Dispenser	96	TEC233 Take It Out (TIO) Fabric Cleaner/Protectant RTU	34
S-100BATTERY Tornador® S-100C 18V Battery	59	TEC1208 Microfiber Towel - Blue	107	TEC1357 Kitchen Paper Towels	96	TEC236 Magnifico	18
T-21 Tornador® Dual Action Polisher	52	TEC1209 Microfiber Towel - Yellow, Large	107	TEC1358 Toilet Tissue - Individual	96	TEC237 Truck Wash	24
T-21C Tornador® Cordless Dual Action Polisher	52	TEC1210 Microfiber Towel - Bulk	107	TEC1359 C-Fold Towels	96	TEC239 Blackhawk HD Cleaner & Degreaser	45
T-21BATTERY Tornador® T-21C 21V Battery	52	TEC1211 Magic Mop Rubber Frame	102	TEC136 Sani-Touch Premium Gel Hand Sanitizer	33	TEC24 Express Detailer	78
TEC1000 2 Quart Sprayer	105	TEC1212 Round Upholstery Brush	87	TEC1361 Non-Abrasive Hand Pads	95	TEC240/77 Green All-Purpose Cleaner	18
TEC1003 Knit Wax Applicator Pad	84	TEC1213 Round Upholstery Brush	87	TEC1362 Green General Purpose Hand Pads	95	TEC243 Anti-Scaler	40
TEC1004 Wool Pad Spur	95	TEC1214 Quic-Dry Vehicle Dry Blade	107	TEC1360 Facial Tissue	100	TEC244 I Can't Believe it's Not Acid Wheel Cleaner™	44
TEC1005 Microfiber Coating Applicator Sponge	84	TEC1215 Magician's Sponge	95	TEC1400 Spray Socks	100	TEC246 3-in-1 Surface Clarifier™	40
TEC1006 Knit Wax Applicator Pad-Large	84	TEC1216 Cleaning Sponge	95	TEC1401 Respirator - Medium	100	TEC249 Awesome Pink APC/Degreaser	18
TEC1007 Foam/Terry Wax Applicator	84	TEC1217 Microfiber Sponge with Bug Scrubber	84	TEC1402 Respirator - Large	100	TEC250 Anti-Static Cleaner/Polish	67
TEC1008 Round Knit Applicator	84	TEC1218 Plastic Drum Pump	89	TEC1403 Respirator Particle Mask	100	TEC252 Glass Cleaner	30
TEC1009 Mini Orbital Bonnets	95	TEC1219 Steel Drum Pump	89	TEC1413 Do-All Scrubber	84	TEC254 Vision Glass Cleaner RTU	30
TEC1011 Wheel/Fender Brush	86	TEC1220 Gallon Pump Dispenser	89	Blue Nitrile Powder-Free Examination Gloves	89	TEC255 Citrus Vision Glass Cleaner	30
TEC1012 21" Wheel/Fender Brush	86	TEC1221 Tornador® Cleaning Tool	88	TEC1420 Small	89	TEC258 Brake-R Non-Acid Tire & Wheel Cleaner	42
TEC1013 Brass Tire Brush	86	TEC1222 Tornador® Repair Kit	61	TEC1421 Medium	89	TEC259 Brake-X WB Brake & Parts Cleaner/Degreaser	45
TEC1014 Nylon Tire Brush	86	TEC1223 Tornador® Cone with Brush	62	TEC1422 Large	89	TEC260 Leather Cleaner RTU	35
TEC1015 Detail Paint Brush	86	TEC1224 Tornador® Cone	62	TEC1423 X-Large	61	TEC265 Plastic Cleaner	35
TEC1016 Fabric/Floor Mat Brush	86	TEC1225 Tornador® Replacement Cap	62	Black Nitrile Powder-Free Examination Gloves	62	TEC2750 Medium Grade Clay Mitt	67
TEC1017 All-Purpose Scrub Brush	86	TEC1226 Tornador® Siphon Tube	62	TEC1424 Medium	62	TEC2760 Medium Grade Clay Towel	67
TEC1018 Detail Brush	86	TEC1227 Tornador® Cap without Hole	62	TEC1425 Large	62	TEC2770 Fine Grade Clay Mitt	67
TEC1019 Detail Brush	86	TEC1228 Tornador® 32 oz. Jar	62	TEC1426 X-Large	62	TEC2780 Fine Grade Clay Towel	67
TEC1020 12 oz. Squeezeable Bottle	105	TEC1229 Tornador® Brass In-Line Regulator	62	TEC1427 XX-Large	62	TEC285 Deodorizer	38
TEC1021 #9 Heavy Duty Razor Blades	91	TEC1230 Tornador® Weighted Tube	62	Micro-Textured Powder-Free Latex Examination Gloves	62	TEC286 Rid-It Deodorizing Kit	38
TEC1022 Retractable Window Scraper	91	TEC1231 Tornador® Inner Liquid Tube Fitting	62	TEC1428 Small	62	TEC287 Rid Odor PRO - New Car	38
TEC1023 3/4" Drum/Pail Faucet	89	TEC1232 Tornador® Replacement Cone w/SS Lining	62	TEC1429 Medium	62	TEC288 Rid Odor PRO - Leather	38
TEC1024 16"x20" Medium Weight Sorbent Pad	90	TEC1233 Tornador® Black Cleaning Tool	58	TEC1430 Large	62	TEC289 Rid Odor PRO - Application Tool	38
TEC1025 30"x150" Medium Weight Sorbent Roll	90	TEC1235 Tornador® Blow Gun	58	TEC1431 X-Large	62	TEC300 Odorless Mineral Spirits	44
TEC1026 16"x20" Single Weight Sorbent Roll	90	TEC1236 Tornador® Velocity Vac	59	Powder-Free Textured Heavy Duty Latex Gloves	58	TEC3040 Pre-Washed Lambswool Pad	92
TEC1029 Mini Scraper	91	TEC1236 Tornador® Velocity Vac Dry	59	TEC1432 Small	58	TEC305 Clean Screen - Electronic Screen Cleaner	40
TEC1030 16"x20" Heavy Weight Sorbent Roll	90	TEC124 Hand Cleaner Dispenser	32	TEC1433 Medium	101	TEC3050 Pad Washer	95
TEC1031 Premium Synthetic Chamois	106	TEC1240 Foam-A-Nator	59	TEC1434 Large	101	TEC307 Traffic Paint Remover	82
TEC1032 Vent Brush	86	TEC1245 HD Citrus Hand Cleaner with Fine Pumice	91	TEC1435 X-Large	101	TEC309/88 Wire Wheel Cleaner	43
TEC1033 Upholstery Brush	86	TEC1250 Steel Wool 00	91	TEC1436 XX-Large	101	TEC310 Tough Stuff Wire Wheel Cleaner	43
TEC1034 Bug Sponge	84	TEC1251 Steel Wool 000	91	Powder-Free Textured Heavy Duty Latex Gloves	32	TEC311 So-Cal Bulk Brake Cleaner	81
TEC1035 Premium Car Wash Brush	102	TEC1252 Steel Wool 0000	91	TEC1437 Medium	91	TEC313 California Bulk Brake Cleaner	81
TEC1036 Premium Wood Handle	102	TEC1255 Single-Edged Plastic Razor Blades	91	TEC1438 Large	101	TEC314 Blast Off Brake Cleaner	82
TEC1041 Spoke Brush	86	TEC1256 Fireman's Nozzle	107	TEC1439 X-Large	101	TEC315 VOC/OTC Compliant NC Brake Cleaner	82
TEC1042 Red Shop Towels	103	TEC1260 The Detail Chemical Organizer Cart	65,104	Powder-Free Textured Nitrile Gloves	107	TEC316 Fuel System Cleaner: Step 1	80
TEC1043 100% Cotton Diapers	103	TEC1261 Standard 50' Water Hose	107	TEC1441 Large	101	TEC317 Induction Cleaner: Step 3	80
TEC1044 Terry Cloth Towel	103	TEC1262 Premium 50' Water Hose	107	TEC1442 X-Large	107	TEC318 Complete Fuel System Treatment Kit	80
TEC1045 Fireman's Friend Chamois	106	TEC1263 Standard Air Hose	56	HD Orange Nitrile Textured Powder-Free Gloves	107	TEC319 Spray Cleaner	19
TEC1046 Heavy Duty Turbo Sprayer	88	TEC1264 Deluxe Air Hose	56	TEC1443 Medium	101	TEC319G Green Spray Cleaner	19
TEC1047 Blue Window Huck Towel	103	TEC127 Blue Velvet Skin Care Hand & Body Soap	32	TEC1444 Large	101	TEC320 Dissolve-All Citrus All-Purpose Cleaner	19
TEC1048 1/2 Bath Towels	103	TEC1270 Heavy Weight Microfiber Towel - Orange	107	TEC1445 X-Large	101	TEC322 Hot Stuff All-Purpose Cleaner	19
TEC1049 Premium Synthetic Chamois - Large	106	TEC1271 Two-Sided Microfiber Towel	107	TEC1446 XX-Large	101	TEC324 Happy Medium Floor Cleaner	28
TEC1050 5# Roll Polishing Cloth	103	TEC1278 Knock-Out HD Hand Soap with Scrubbing Beads	33	TEC1506 Soft Edge Rigid Urethane Back Plate	92	TEC325 Blue Sapphire Dressing	50
TEC1051 No Cuff Wash Mitt	106	TEC128 Handi Wipes Hand Cleaner Towels	106	TEC1507 Soft Edge Flexible Urethane Back Plate	92	TEC328 Jeannie Vehicle Interior Cleaning Solution	39
TEC1052 Long Razor Scraper	91	TEC1300 Cherry Blast HD Hand Soap	32	TEC1510 Universal Back Plate	92	TEC329 Jeannie Vehicle Air Quality Unit	57
TEC1055 Floor Mat Clip	90	TEC1301 Economy Seat Cover	99	TEC1512 8" Waffle Pad - Yellow	93	TEC3500 Pressure Washer	39
TEC1056 Premium Synthetic Chamois - Small	102	TEC1307 DMR Plastic Adhesive Floor Mat	97	TEC1521 8" Waffle Pad - Green	93	TEC360/49 Heavy Duty Floor Cleaner	28
TEC1057 Steel Wool 00 5 lb. Roll	87	TEC1308 DMR Plastic Adhesive Floor Mat - L	97	TEC1522 8" Waffle Pad - White	93	TEC370/25 Engine Shampoo	45
TEC1059 3/4" Faucet	85	TEC131 Super Strength Scrubber Towels	33	TEC1523 8" Waffle Pad - Blue	93	TEC375/86 Super Solvent	44
TEC1061 Orbital Buffer Pad - White	91	TEC1317 SNG Floor Start Up Kit	98	TEC1524 8" Waffle Pad - Red	93	TEC378 Lacquer Thinner	82
TEC1062 Orbital Buffer Pad - Black	91	TEC1318 SNG Wall Start Up Kit	98	TEC1525 6" Waffle Pad - Yellow	93	TEC381 SuperB Floor Cleaner	28
TEC1063 Orbital Buffer Pad - Orange	91	TEC1319 SNG Floor Display Rack	98	TEC1526 6" Waffle Pad - Blue	93	TEC386 Solution Now	44
TEC1065 Correct-It Scrubber	91	TEC1320 SNG Wall Display Rack	98	TEC1527 6" Waffle Pad - Red	93	TEC387 Orange Crush All-Purpose Cleaner/Degreaser	19,45
TEC1066 Black Sure Shot	106	TEC1321 SNG Adhesive Display Rack	98	TEC1540 5" Hook & Loop Back Plate	98	TEC388 Fallout Wash Gel	40
TEC1068 Heavy Duty Utility Knife	91	TEC1322 Premium Seat Cover - Roll	99	TEC1541 XPC3® 3" Step 1 Level Pad	94	TEC389 A-1 Industrial Strength Floor Cleaner Conc.	28
TEC1069 Utility Knife Blades	91	TEC1325 Plastic Floor Mat	97	TEC1542 XPC3® 3" Step 2 Polish Pad	94	TEC391 Do All Enzyme Cleaner	35
TEC1070 Correct-It Clay Pad	66	TEC1326 Steering Wheel Cover	99	TEC1543 XPC3® 3" Step 3 Glamour Pad	94	TEC392 Heavy Duty Enzyme Spot & Stain Remover	35
TEC1073 Wire Wheel/Spoke Brush	86	TEC1327 Tire Bag	99	TEC1544 XPC3® Back Plate	94	TEC399 Sani-Tec Detergent/Deodorizer	19
TEC1074 Short Utility Brush	86	TEC1328 Parts Bag	99	TEC1545 XPC3® Step 1 Level Pad	94	TEC400/34 New Gloss Dressing	46
TEC1075 Hand Wringer	106	TEC1329 Service Numbers #000-999	99	TEC1546 XPC3® Step 2 Polish Pad	94	TEC401/31 Snappy Purple Tire Dressing	47
TEC1076 Parts/Vent Brush	83	TEC133 Sani-Touch Hand Sanitizer & Conditioner	33	TEC1547 XPC3® Step 3 Glamour Pad	94	TEC402 Ice Purple Tire Dressing	47
TEC1077 Small Detail Brush	83	TEC1330 Service Numbers #1000-1999	99	TEC1548 5" Euro Microfiber Pad	94	TEC404/36 Snappy Shine Tire Dressing	48
TEC1078 2-Sided Detail Brush	83	TEC1331 Service Numbers #2000-2999	99	TEC1549 6" Euro Microfiber Pad	94	TEC404/36V Snappy Shine Tire Dressing VOC/OTC	47
TEC1079 #12 Razor Blades	87	TEC1332 Key Tag - White	99	TEC1550 Premium Standard Wash Mitt	106	TEC405/37A New Tire Dressing	47
TEC1081 Polyback Floor Mat	93	TEC1333 Key Tag - Red	99	TEC1551 Premium Oversized Wash Mitt	106	TEC408 Ice Blue Tire Dressing	48
TEC1082 Black PVC Gloves 14"	96	TEC1334 Work/Repair Order Holder	99	TEC1560 Jumper Pack Rescue 900	56	TEC410/89 Rubber & Vinyl Dressing Original	50
TEC1083 Black PVC Gloves 18"	96	TEC1335 Premium Seat Cover - Box	99	TEC1572 5" Hook & Loop Carpet Brush	87	TEC414 Reflections	46
TEC1084 Aqua-Foamer Sprayer	87	TEC1336 Seat Jacket	99	TEC1573 5" Hook & Loop Upholstery Brush	87	TEC415 Cherry Shine Tire Dressing VOC/OTC	47
TEC1085 Multi-Purpose Cleaning Brush	87	TEC1337 DMR Plastic Adhesive Floor Mat - 4 mil	97	TEC1574 Tire Dressing Applicator Pad	87	TEC416 Shine All Tire Dressing VOC/OTC	47
TEC1086 Brass Sidewall Brush	87	TEC1339 Service Numbers #3000-3999	99	TEC160 Clay - Gray (Fine Grade)	66	TEC417 Blue Velvet Tire Dressing	56
TEC1087 White Sidewall Brush	87	TEC134 Eco-Soap Foaming Hand Soap	33	TEC1602 Mini Air Tool	53	TEC417GUN Blue Velvet Precision Applicator	56
TEC1089 Synthetic Wash Mitt	106	TEC1340 Service Numbers #4000-4999	99	TEC1603 Steel Piston Pump	53	TEC418 Perfect Tire Dressing	49
TEC1090 Synthetic Wash Mitt with Bug Remover	106	TEC1341 Service Numbers #5000-5999	99	TEC1604 Polypropylene Piston Pump	89	TEC419 One & Done™ Interior Cleaner & Cond. RTU	35
TEC1092 Double-Edged Plastic Razor Blades	102	TEC1342 Service Numbers #6000-6999	99	TEC1610 E-15 RO/DA Polisher	53	TEC421 Tool & Parts Cleaner	82
TEC1093 Wheel Brush	91	TEC1343 Service Numbers #7000-7999	99	TEC1611 E-12 RO/DA Polisher	53	TEC426 Aqua Glow	78
TEC1094 Car Wash Brush	102	TEC1344 Service Numbers #8000-8999	99	TEC170 Clay - Red (Medium Grade)	70	TEC426 Aqua Glow	78
TEC1098 20" Utility Brush	102	TEC1345 Service Numbers #9000-9999	99	TEC200 Premium Paste Wax	28	TEC427/76 Super Dress Dressing	50
TEC1099 Bi-Level Truck Wash Brush	102	TEC1346 Night Drop Envelope	99	TEC200/98 Suds to the Ceiling	74	TEC432 Clear Dressing	49
TEC1102 Bi-Level Unflagged Brush	102	TEC1347 Key Tag - with Ring	99	TEC206 Super Suds	25	TEC434 Shine & Shield Conditioner Dressing	50
TEC1113 Industrial Paint Brush	87	TEC1348 Shift Knob Cover	99	TEC207 Purpicious Car Wash	24	TEC435 Rubber & Vinyl Dressing Concentrate	51
TEC1114 Economy Paint Brush	87	TEC1349 Key Fob Bag	99	TEC208 Blue Stuff	24	TEC436 Red Silicone-Free Dressing	49
TEC1116 Pet Stone	90	TEC135 Nutty Butter HD Hand Soap w/ Walnut Shells	32	TEC209 Waterless Car Wash	24	TEC437 Whitewall Tire Cleaner	42
TEC1124 16"x20" Oil Only Sorbent Roll	90	TEC1350 Blue Mechanix Wipes	96	TEC2100 32 oz. Spray Bottle	27	TEC440 Leather Conditioner	35
TEC1203 Magic Mop	102	TEC1351 Mechanix Wipe Dispenser	96	TEC2121/87 Super Beads Rinse Agent	105	TEC445 Blue Coat Vinyl Coating	83
TEC1204 Magic Mop Head	102	TEC1352 Klean & Prep Wipe	96	TEC22 Purple Premium Finishing Wax	78	TEC450/38 Bumper Restorer	48
TEC1205 30" Floor Squeegee	102	TEC1353 Center Pull Towel	96	TEC23 Final Finish	96	TEC451 Progressive™ Dressing - Water-Based	49
TEC1206 Microfiber Waffle Towel	107	TEC1354 Toilet Tissue	96	TEC230 Upholstery Shampoo	34	TEC452 Progressive™ Dressing - Solvent-Based	46
		TEC1355 Toilet Tissue Dispenser	96	TEC231 C&U Extractor Shampoo w/Anti-Scaler	34	TEC453 Progressive™ Dressing - Solvent-Based - Low VOC	46
				TEC232 Carpet & Upholstery Extractor Shampoo	34	TEC459 2-Hot Stuff	20
						TEC460 Purpose Multi-Purpose Cleaner	20
						TEC460D Purpose Multi-Purpose Cleaner	20

Table listing various cleaning products and their prices, organized in columns. Includes items like 'Big Red All-Purpose Cleaner', 'Whitewall Tire Cleaner Concentrate', 'Cleaning Brush for Foam Pads', etc.



When you see this symbol associated with our products, please note that this is a special order item and that it may require additional time for production and/or shipping.

PCW INDEX

Products in Order of Item Number

Chemicals (in order of item #)	Page		
PCW1 Gold Foam Polish	116	PCW88 Triple Shine TVP	118
PCW2 Pink Foam Polish	116	PCW95 Purple Foam Polish/Conditioner	116
PCW3 Blue Foam Polish	116	PCW96 Orange Foam Polish/Conditioner	116
PCW4 Platinum - TVP Original	118	PCW97 Green Foam Polish/Conditioner	116
PCW5 Invision Protectant	118	PCW98 Lava Wax Orange	119
PCW6 Clear Vision Rain Repellant	122	PCW99 Lava Wax Cherry Passion	119
PCW7 Foaming Tire Cleaner	114	PCW100 Lava Wax Grape	119
PCW8 TNT High pH Pre-Soak	112	PCW101 Blue Citrus Foamy Lube	113,115
PCW9 Super Beads Drying Agent	118	PCW102 Platinum Ceramic Shield®	120
PCW12 Bug-a-Boo	122	PCW302 Fragrance Booster - Lemon	123
PCW13 Cherry Drying Agent	118	PCW303 Fragrance Booster - Spearmint	123
PCW14 Easy Rinse Low pH Pre-Soak	113	PCW305 Fragrance Booster - Grape	123
PCW15 Super Foamer	113,115	PCW306 Fragrance Booster - Watermelon	123
PCW18 Take Off High pH Pre-Soak	112	PCW307 Fragrance Booster - Cherry	123
PCW19 Premium Pre-Soak Powder	112	PCW308 Fragrance Booster - Cool Breezzz	123
PCW20 Blue Polish II/Conditioner	116	PCW309 Fragrance Booster - Fresh Air	123
PCW21 Pink Polish II/Conditioner	116		
PCW22 Yellow Polish II/Conditioner	116		
PCW23 Shiner High Foaming Low pH Pre-Soak	113	Equipment (in order of item #)	Page
PCW24 WOW! Whitewall & Wheel Cleaner	114	ECP2201 1-Port Proportioner	124
PCW25 BAM! Tire & Wheel Cleaner	114	ECP2202 1-Port Drum Mount Proportioner	124
PCW29 Purple Magic Wheel Brightener	114	ECP2203 3-Port Proportioner	124
PCW30 Terminator	114	PCWD14MZ2 Dosatron® D14MZ2	124
PCW31 Vanish High pH Pre-Soak	112	PCWD14MZ5 Dosatron® D14MZ5	124
PCW32 Buffered High pH Pre-Soak	112	PCWD25RE1500 Dosatron® D25RE1500	124
PCW33 Citrus Foam Low pH Pre-Soak	113	PCWPR34 Water Pressure Regulator	124
PCW34 Sahara Drying Agent	118	PCW514 Titration Kit	125
PCW36 Foamy Lube Detergent	112,115	PCW675 100 mL Graduated Cylinder	125
PCW38 No Freeze Red	115	PCW676 250 mL Graduated Cylinder	125
PCW42 Premier Tunnel & Equipment Cleaner	122	PCW677 500 mL Graduated Cylinder	125
PCW47 Platinum - TVP Blue	118		
PCW49 Cherry Foam Brush	115		
PCW52 Film Fighter High pH Pre-Soak	112		
PCW53 Innovation Low pH Pre-Soak	113		
PCW54 FASTBREAK Red Triple Foam	117		
PCW55 FASTBREAK Yellow Triple Foam	117		
PCW56 FASTBREAK Blue Triple Foam	117		
PCW57 Rust Inhibitor	122		
PCW60 Leather Conditioner Interior Dressing	122		
PCW61 Zapper Bug Remover	122		
PCW62 Vivid Dry Rinse Aid	118		
PCW63 Pad Master On-Line Dressing	121		
PCW64 H2O Pad Master On-Line Dressing	121		
PCW65 FASTBREAK Blue Low pH Triple Foam	117		
PCW66 FASTBREAK Pink Low pH Triple Foam	117		
PCW67 FASTBREAK Yellow Low pH Triple Foam	117		
PCW68 Lemon Foam Brush	115		
PCW69 Tri-Foam Combo Green	115		
PCW70 Cherry Blast Car Wash	115		
PCW71 Strawberry Sheen Dressing	121		
PCW72 Triple-D Dressing	121		
PCW74 White Cherry Dressing	121		
PCW75 Liquid Laundry Detergent	122		
PCW76 Sprayable Paint Protection	122		
PCW79 Terminator II Powered Up	114		
PCW84 Foamy Lube Gold	112,116		
PCW85 Foamy Lube Red	112,116		
PCW86 Foamy Lube Blue	112,116		

Signage (in order of item #)	Page
PCW519 Platinum Traffic Cone	129
PCW520 Tri-Foam Cone Topper	129
PCW521 Clear Coat Protectant Cone Topper	129
PCW522 Take Your Vehicle Platinum Cone Topper	129
PCW523 Tire Shine Cone Topper	129
PCW524 Total Vehicle Protection Cone Topper	129
PCW525 Car Wash Open Cone Topper	129
PCW526 Platinum Professional Products Cone Topper	129
PCW527 Platinum Ceramic Shield® Cone Topper	129
PCW540 Tri-Foam Banner	126
PCW541 Clear Coat Protectant Banner	126
PCW542 Take Your Vehicle Platinum Banner	126
PCW543 Tire Shine Banner - \$2 Option	126
PCW544 Total Vehicle Protection Banner	126
PCW545 Car Wash Open Banner	126
PCW546 Platinum Professional Products Banner	126
PCW547 Tire Shine Banner	126
PCW548 Lava Wax Banner	126
PCW549 Platinum Ceramic Shield® Banner	126
PCW560 Standard Windmaster Frame w/Stand	127
PCW561 Tri-Foam Standard Windmaster Insert	127
PCW562 Clear Coat Protectant Standard Windmaster Insert	127
PCW563 Take Your Vehicle Platinum Standard Windmaster Insert	127
PCW564 Tire Shine Standard Windmaster Insert - \$2 Option	127
PCW565 Total Vehicle Protection Standard Windmaster Insert	127
PCW566 Car Wash Open Standard Windmaster Insert	127
PCW567 Platinum Professional Products Standard Windmaster Insert	127
PCW568 Tire Shine Standard Windmaster Insert	127
PCW569 Lava Wax - Orange Standard Windmaster insert	127
PCW570 Lava Wax - Cherry Standard Windmaster insert	127
PCW571 Lava Wax - Grape Standard Windmaster insert	127
PCW572 Platinum Ceramic Shield® Standard Windmaster insert	127
PCW580 Mini Windmaster Frame w/wheels	127
PCW581 Tri-Foam Mini Windmaster Insert	127
PCW582 Clear Coat Protectant Mini Windmaster Insert	127
PCW583 Take Your Vehicle Platinum Mini Windmaster Insert	127
PCW584 Tire Shine Mini Windmaster Insert - \$2 Option	127
PCW585 Total Vehicle Protection Mini Windmaster Insert	127
PCW586 Car Wash Open Mini Windmaster Insert	127
PCW587 Platinum Professional Products Mini Windmaster Insert	127
PCW588 Tire Shine Mini Windmaster Insert	127
PCW600 Tri-Foam Curb Sign	128
PCW601 Clear Coat Protectant Curb Sign	128
PCW602 Take Your Vehicle Platinum Curb Sign	128
PCW603 Tire Shine Curb Sign - \$2 Option	128
PCW604 Total Vehicle Protection Curb Sign	128
PCW605 Car Wash Open Curb Sign	128
PCW606 Platinum Professional Products Curb Sign	128
PCW607 Tire Shine Curb Sign	128
PCW620 Antenna Windmaster Frame	128
PCW621 Tri-Foam Antenna Windmaster Insert	128
PCW622 Clear Coat Protectant Antenna Windmaster Insert	128
PCW623 Take Your Vehicle Platinum Antenna Windmaster Insert	128
PCW624 Tire Shine Antenna Windmaster Insert - \$2 Option	128
PCW625 Total Vehicle Protection Antenna Windmaster Insert	128
PCW626 Car Wash Open Antenna Windmaster Insert	128
PCW627 Platinum Professional Products Antenna Windmaster Insert	128
PCW628 Tire Shine Antenna Windmaster Insert	128

PCW640 Tri-Foam Drum Cover	129
PCW641 Clear Coat Protectant Drum Cover	129
PCW642 Take Your Vehicle Platinum Drum Cover	129
PCW643 Tire Shine Drum Cover	129
PCW644 Total Vehicle Protection Drum Cover	129
PCW645 Car Wash Open Drum Cover	129
PCW646 Platinum Professional Products Drum Cover	129
PCW647 Platinum Ceramic Shield® Drum Cover	129

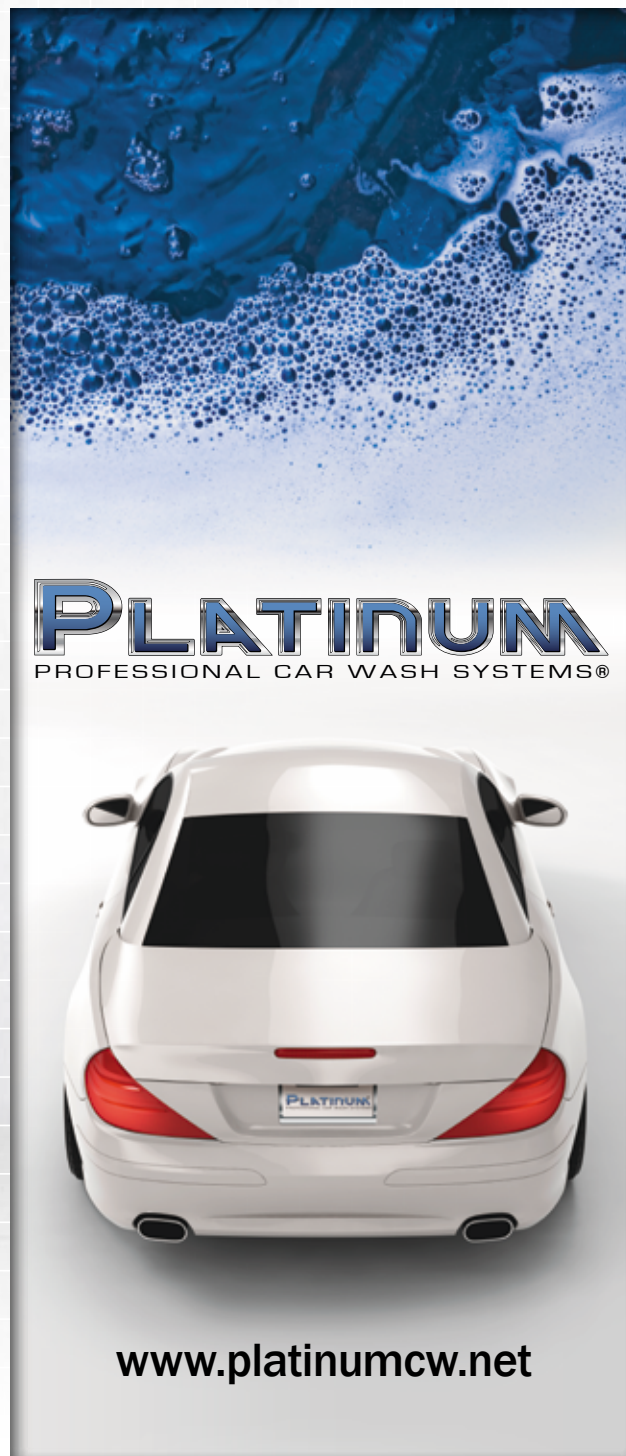

Product Use Guide

1 1st Presoak Arch

2 CTA -Tire, Wheel & Whitewall

3 2nd Presoak Arch

4 Mitter, Wrap, & Cloth

5 Mitter, Wrap & Cloth

6 Triple Foam Applicator

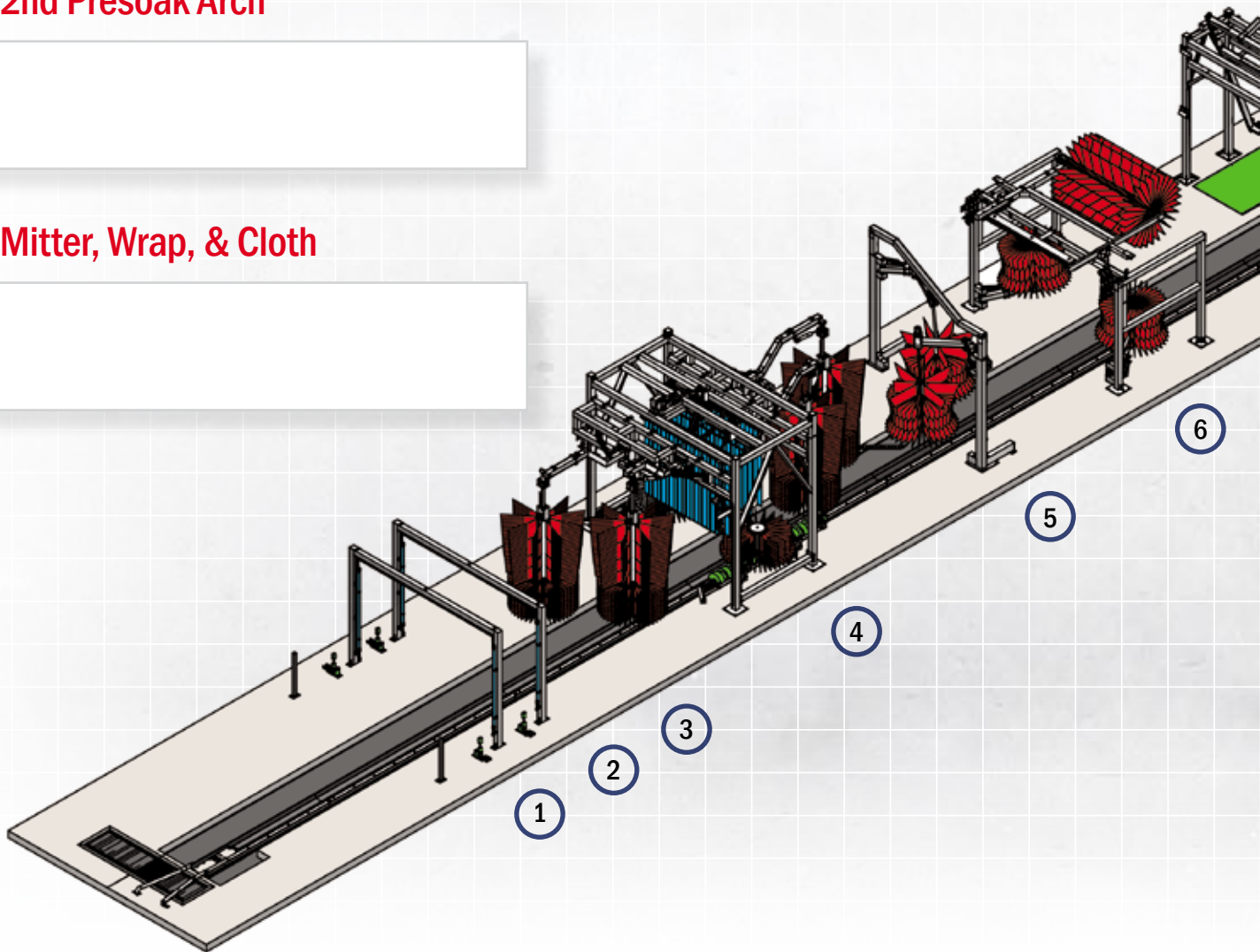

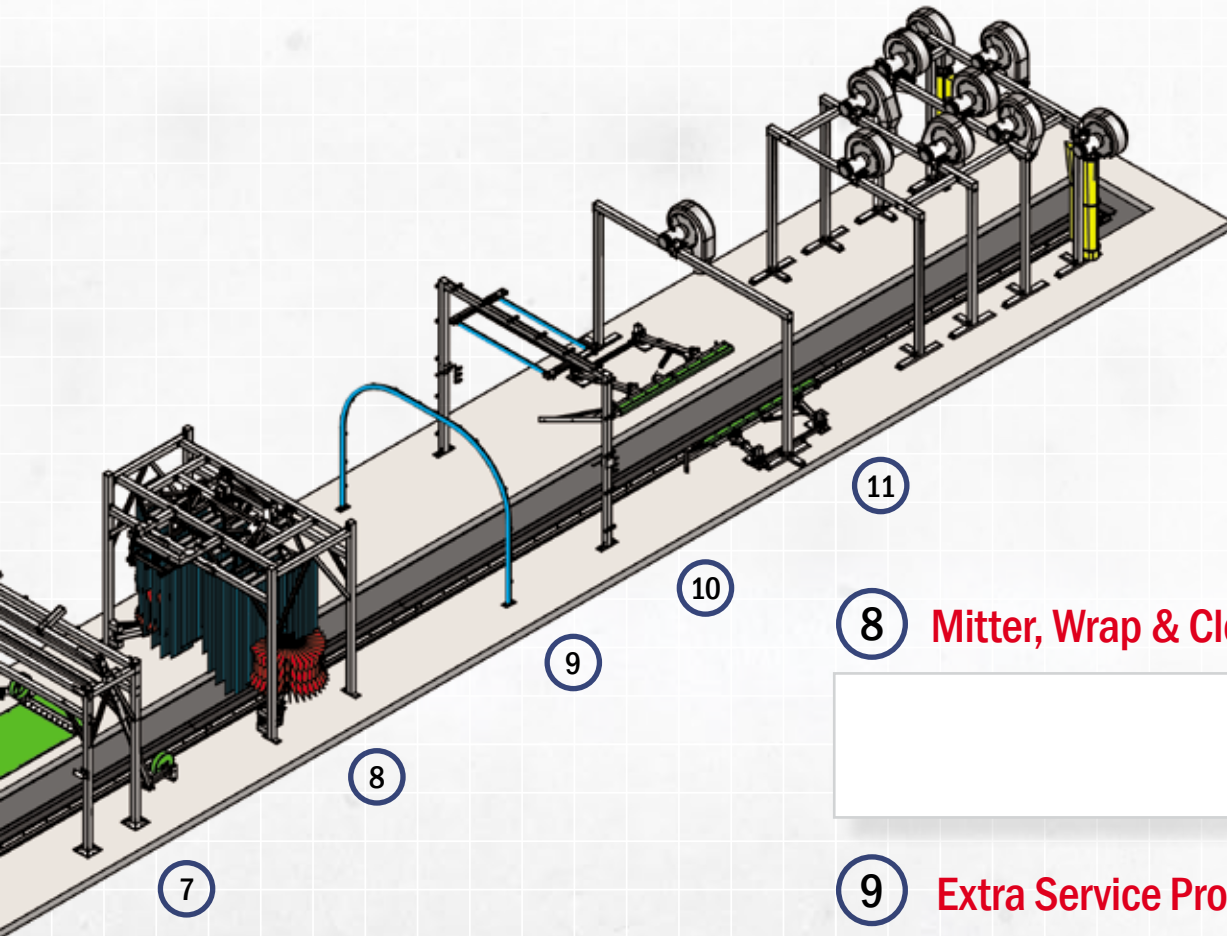

7 Wheel Washer

11 On-Line Dressing

8 Mitter, Wrap & Cloth

9 Extra Service Products

10 Rinse & Drying Agents

Tomorrow's Technology Today

TECHNICIAN'S CHOICE®

PROFESSIONAL SERIES

PLATINUM
PROFESSIONAL CAR WASH SYSTEMS®

A FAMILY of BRANDS FROM



Entire Car Protection



Serving the automotive industry since 1969
Innovations in chemistry since 1935



Quality, experience & trusted performance are built into all of our national brands.

ECP Incorporated
11210 Katherine's Crossing
Suite 100
Woodridge, IL 60517



Customer Service
Tel 630.754.4200
Toll Free: 800.323.3521
Toll Free Fax: 800.409.5195

www.technicianschoice.net • www.ecpinc.net • www.tornador.us • www.platinumcw.net

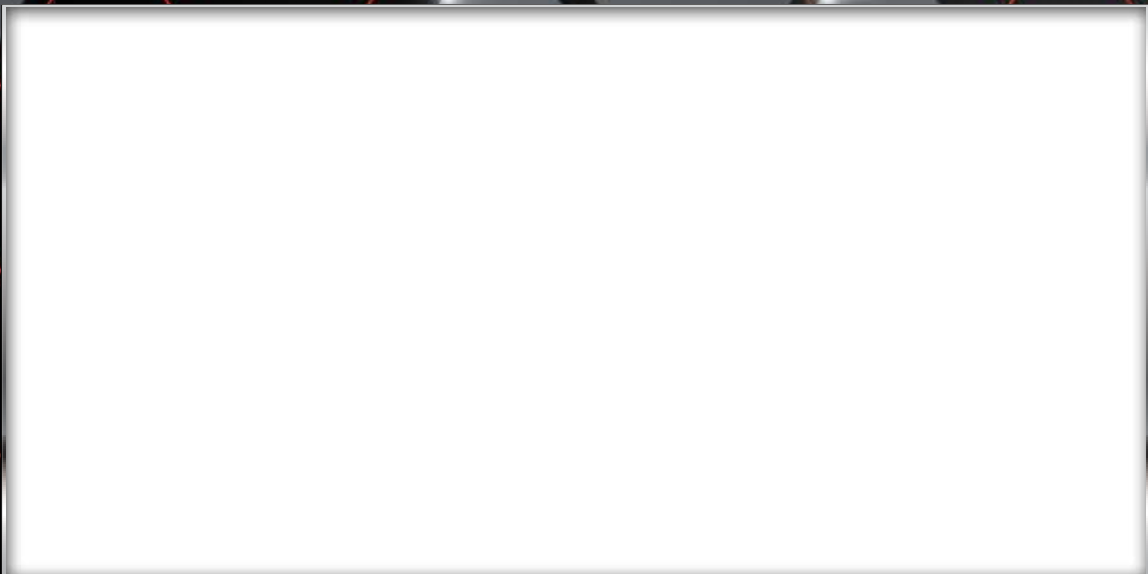

Technician's Choice®, ECP®, Auto Armor®, Platinum Professional Car Wash Systems®, Tornador®, Fragrances Unlimited and The Protector® are registered trademarks, and Detail Xpress is a trademark of ECP Inc. © 2022. Item#102